



NUMBER TRAIN

NUMBERS 1 TO 50



TIMELY PUBLICATION



NUMBERTRAIN

Number Practice Book 1 To 50

B

Name :

Class :Div :Roll No.:

Sub. :

School :

By Mrs. Vaishnavi S. Giri



TIMELY PUBLICATION



Say, Trace and Write.

1	1	1	1	1	1	1	
1	1	1	1	1	1		
1	1	1	1	1			
1	1	1	1				
1	1	1					
1	1						
1							

Date :/...../.....

Remark's :

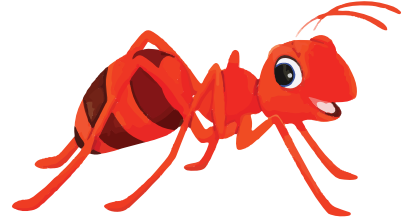
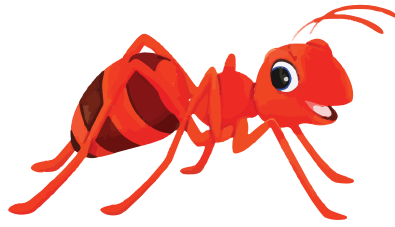

Say, Trace and Write.

2	2	2	2	2	2	2	
2	2	2	2	2	2		
2	2	2	2	2			
2	2	2	2				
2	2	2					
2	2						
2							

3

THREE



Say, Trace and Write.

3	3	3	3	3	3	3	
3	3	3	3	3	3		
3	3	3	3	3			
3	3	3	3				
3	3	3					
3	3						
3							

Date :/...../.....

Remark's :

4

FOUR

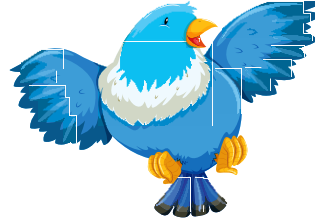
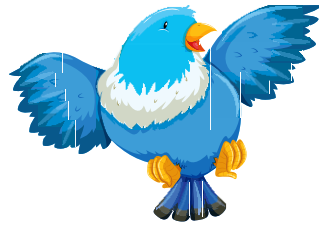

Say, Trace and Write.

4	4	4	4	4	4	4	
4	4	4	4	4	4		
4	4	4	4	4			
4	4	4	4				
4	4	4					
4	4						
4							

Date :/...../.....

Remark's :

5

FIVE

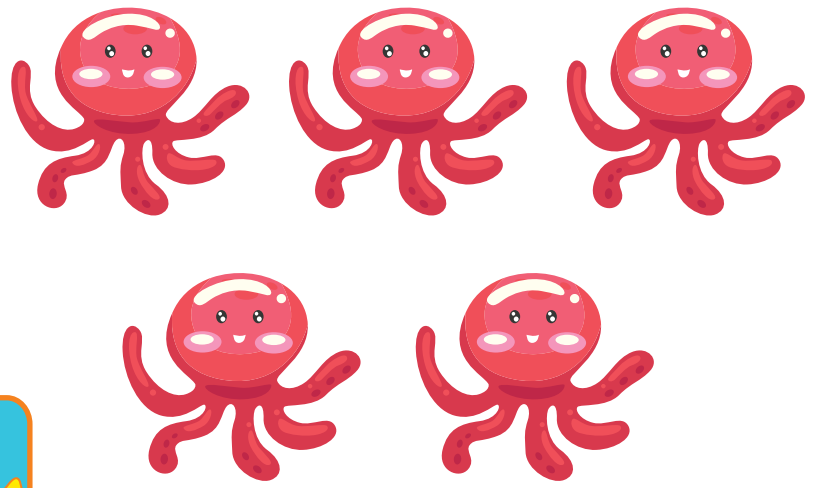

Say, Trace and Write.

5	5	5	5	5	5	5	
5	5	5	5	5	5		
5	5	5	5	5			
5	5	5	5				
5	5	5					
5	5						
5							

6

SIX

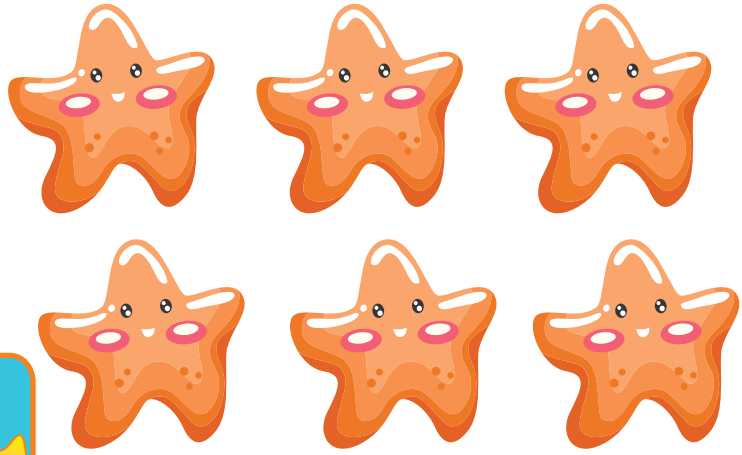

Say, Trace and Write.

6	6	6	6	6	6	6	
6	6	6	6	6	6		
6	6	6	6	6			
6	6	6	6				
6	6	6					
6	6						
6							

Date :/...../.....

Remark's :

7

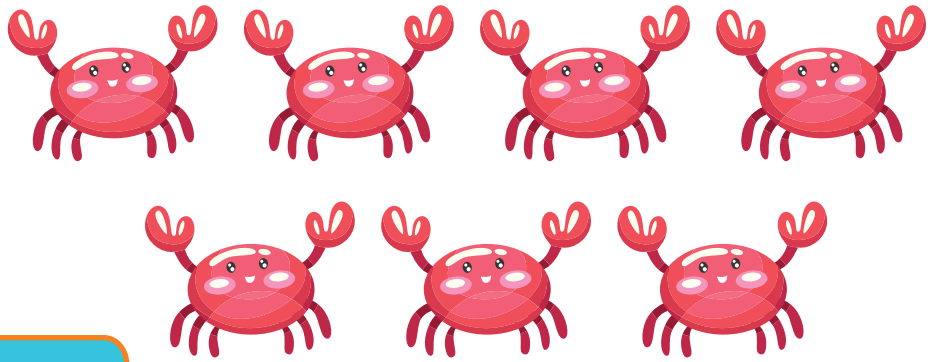

SEVEN

Say, Trace and Write.

7	7	7	7	7	7	7	
7	7	7	7	7	7		
7	7	7	7	7			
7	7	7	7				
7	7	7					
7	7						
7							

Date :/...../.....

Remark's :

8

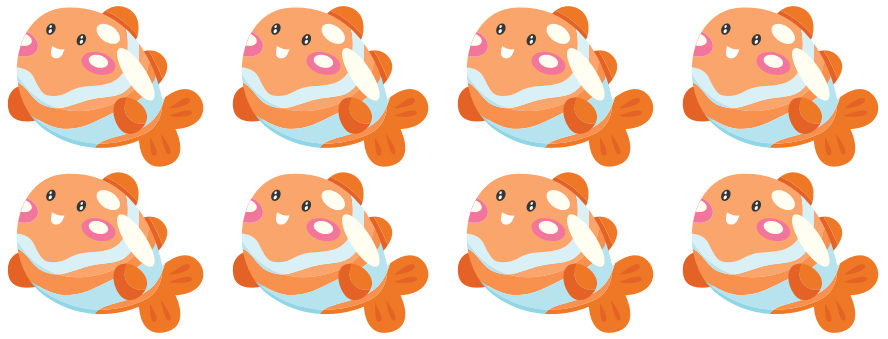

EIGHT

Say, Trace and Write.

8	8	8	8	8	8	8	
8	8	8	8	8	8		
8	8	8	8	8			
8	8	8	8				
8	8	8					
8	8						
8							

q

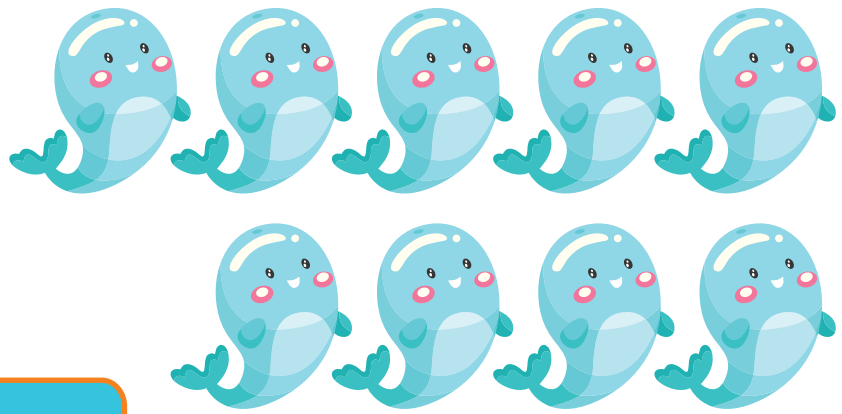

NINE

Say, Trace and Write.

q	q	q	q	q	q	q	
q	q	q	q	q	q		
q	q	q	q	q			
q	q	q	q				
q	q	q					
q	q						
q							

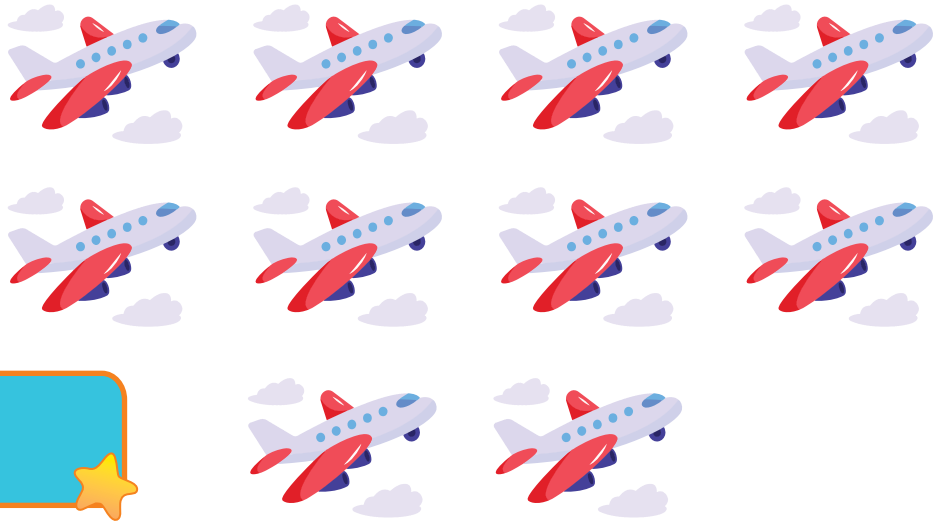

Say, Trace and Write.

10	10	10	10	10	10	10	
10	10	10	10	10	10		
10	10	10	10	10			
10	10	10	10				
10	10	10					
10	10						
10							

Date :/...../.....

Remark's :

PRACTICE WORKSHEET

Q.1). Write the missing numbers between 1 To 10



Q.2). Count and write the numbers.

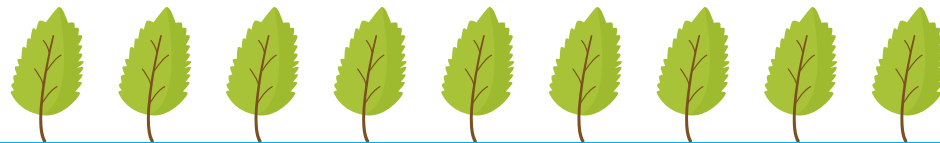

Date :/...../.....

Remark's :

PRACTICE WORKSHEET

Q.3). Trace the number names using different crayons and write the numbers.

One = _____
Two = _____
Three = _____
Four = _____
Five = _____

Six = _____
Seven = _____
Eight = _____
Nine = _____
Ten = _____

Q.4). Write the after numbers.

1 2

4 5

7

8

PRACTICE WORKSHEET

Q.5). Connect the dots and colour the picture.

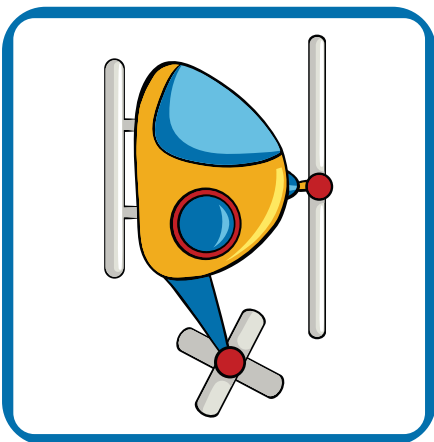
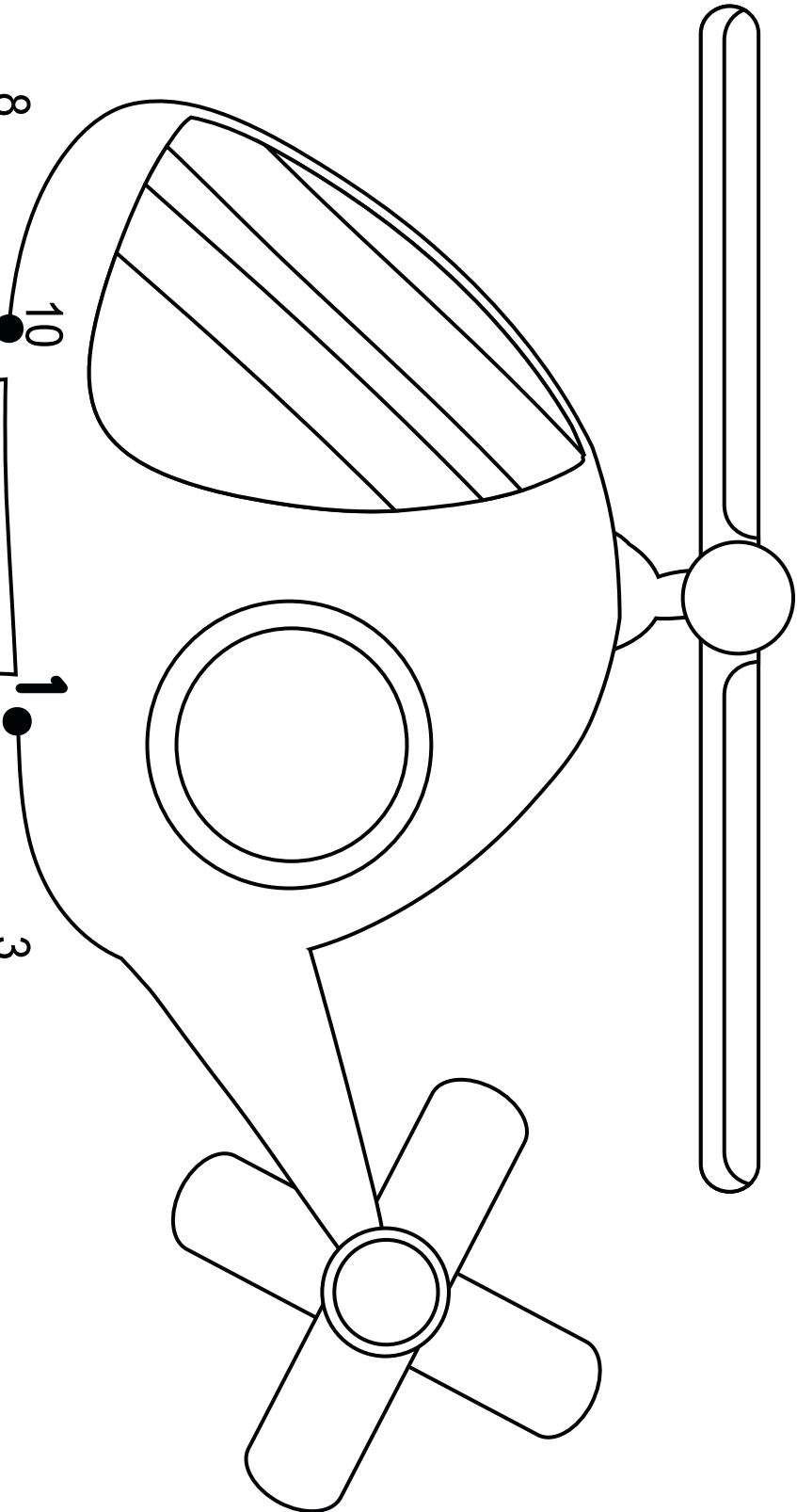
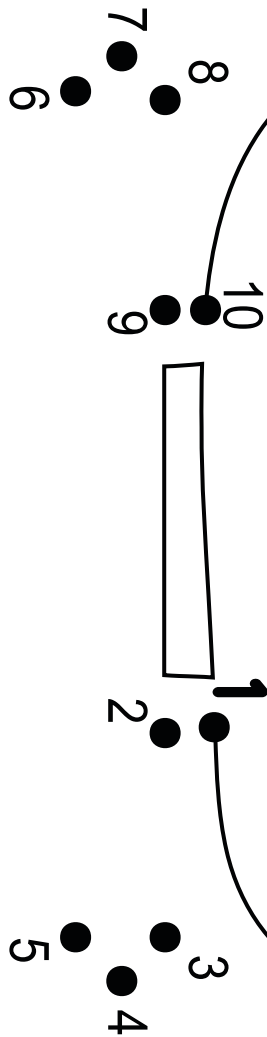

Date :/...../.....

Remark's :



Eleven

Say, Trace and Write.

.....	
.....		
.....			
.....				
.....					
.....						
.....							

Date :/...../.....

Remark's :

12



Twelve



Say, Trace and Write.

12	12	12	12	12	12	12	
12	12	12	12	12	12		
12	12	12	12	12			
12	12	12	12				
12	12	12					
12	12						
12							

Date :/...../.....

Remark's :

13

Thirteen

Say, Trace and Write.

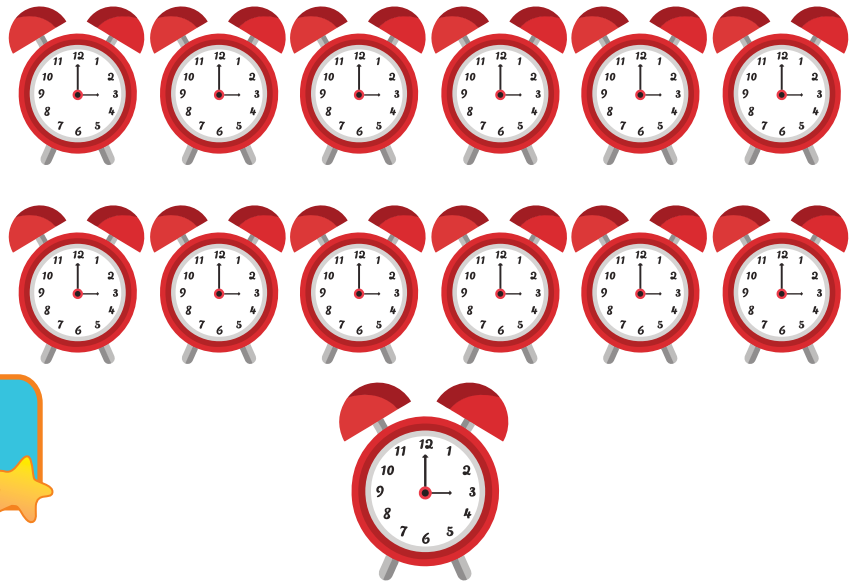

13	13	13	13	13	13	13	
13	13	13	13	13	13		
13	13	13	13	13			
13	13	13	13				
13	13	13					
13	13						
13							

Date :/...../.....

Remark's :

14



Fourteen

Say, Trace and Write.

14	14	14	14	14	14	14	
14	14	14	14	14	14		
14	14	14	14	14			
14	14	14	14				
14	14	14					
14	14						
14							

Date :/...../.....

Remark's :

15

Fifteen

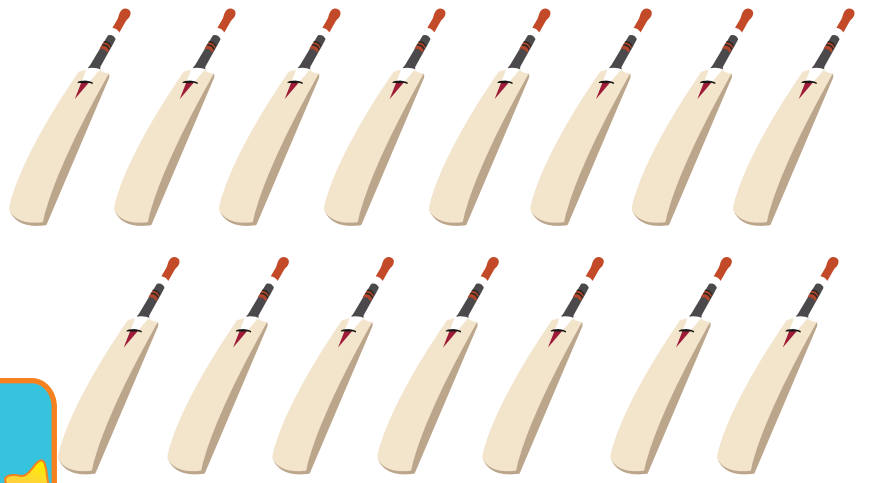

Say, Trace and Write.

15	15	15	15	15	15	15	
15	15	15	15	15	15		
15	15	15	15	15			
15	15	15	15				
15	15	15					
15	15						
15							

Date :/...../.....

Remark's :

16



Sixteen

Say, Trace and Write.

16	16	16	16	16	16	16	
16	16	16	16	16	16		
16	16	16	16	16			
16	16	16	16				
16	16	16					
16	16						
16							

Date :/...../.....

Remark's :

17

Seventeen

Say, Trace and Write.

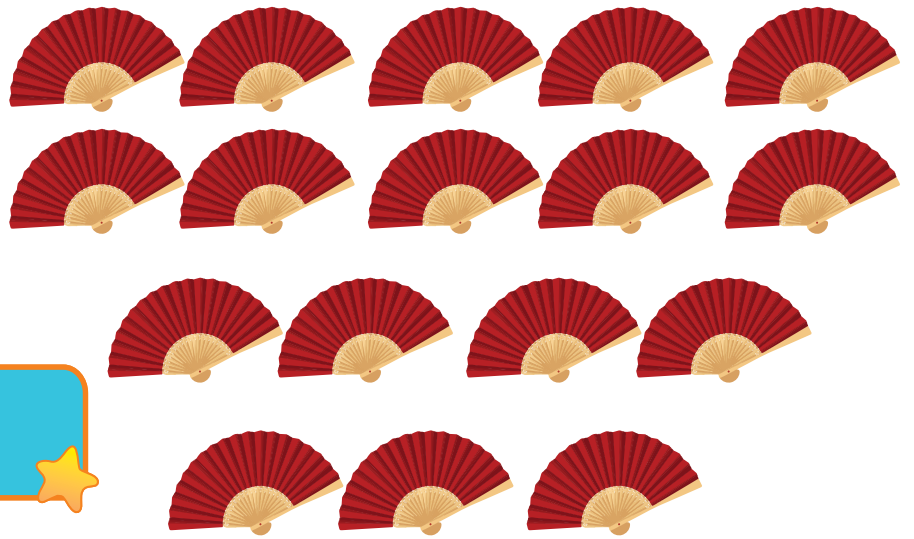

17	17	17	17	17	17	17	
17	17	17	17	17	17		
17	17	17	17	17			
17	17	17	17				
17	17	17					
17	17						
17							

Date :/...../.....

Remark's :

18

Eighteen



Say, Trace and Write.

18	18	18	18	18	18	18	
18	18	18	18	18	18		
18	18	18	18	18			
18	18	18	18				
18	18	18					
18	18						
18							

Date :/...../.....

Remark's :

19

Nineteen



Say, Trace and Write.

19	19	19	19	19	19	19	
19	19	19	19	19	19		
19	19	19	19	19			
19	19	19	19				
19	19	19					
19	19						
19							

Date :/...../.....

Remark's :

20

Twenty

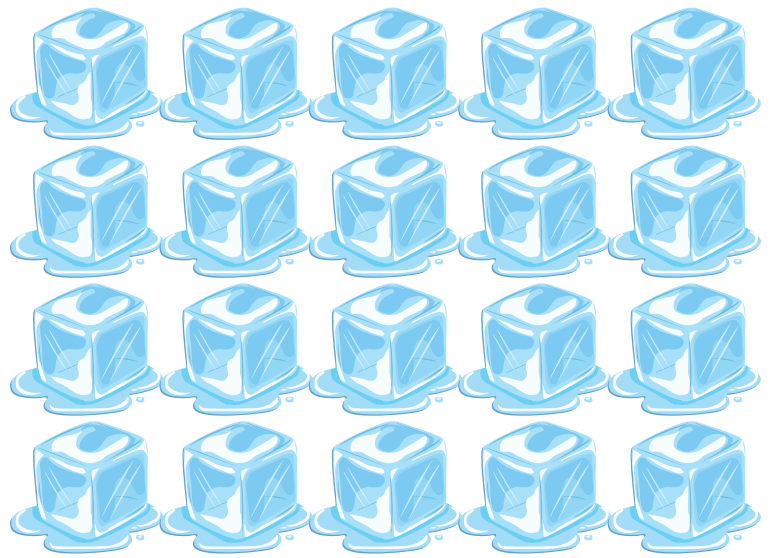

Say, Trace and Write.

20	20	20	20	20	20	20	
20	20	20	20	20	20		
20	20	20	20	20			
20	20	20	20				
20	20	20					
20	20						
20							

Date :/...../.....

Remark's :

PRACTICE WORKSHEET

Q.1). Write the missing numbers between 11 To 20

13

20

16

Q.2). Trace the number names using different crayons and write the numbers.

Twelve = _____

Eighteen = _____

Nineteen = _____

Sixteen = _____

fifteen = _____

Forteen = _____

Eleven = _____

Thirteen = _____

PRACTICE WORKSHEET

Q.3). Count and write the numbers.

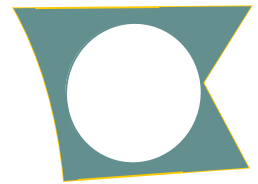
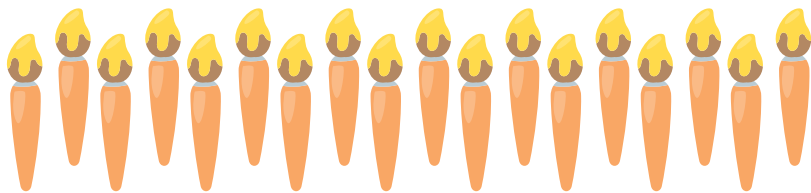
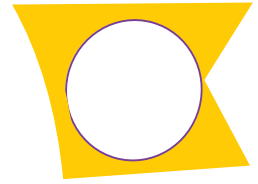
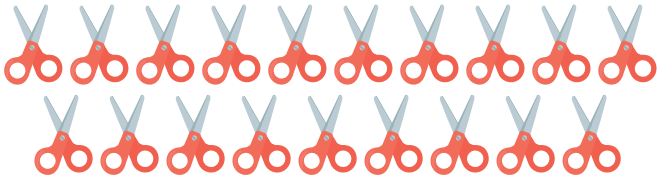
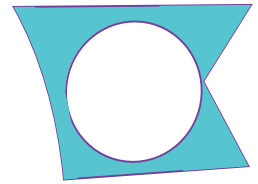
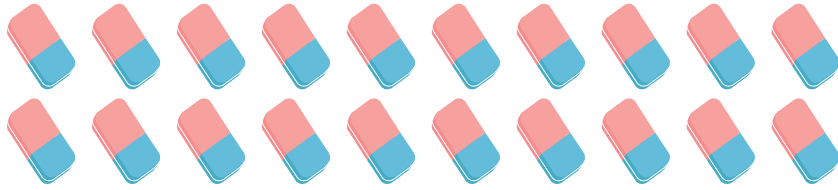

Q.4). Write the before numbers.

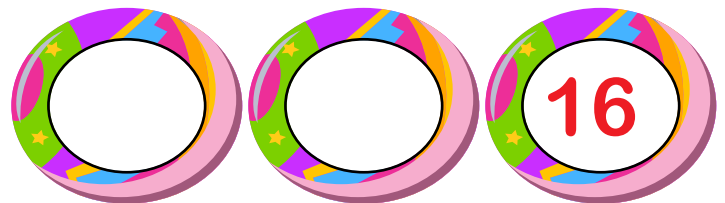
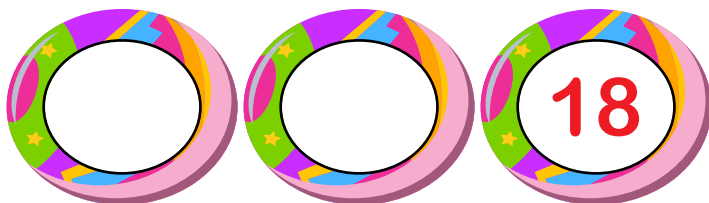
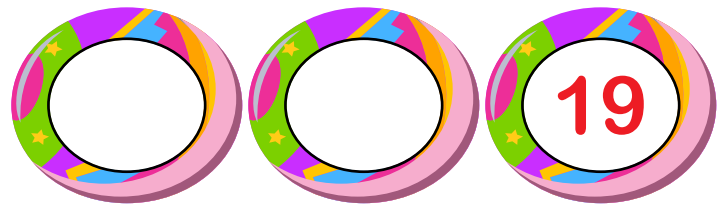

PRACTICE WORKSHEET

Q.3). Count and write How Many are they ?



⚡ ☁ 🌈 ☀ 💧

Date :/...../.....

Remark's :

Fill in the missing numbers from 1 To 20

1			4	
	7		9	
		13		15
		18		20

Date :/...../.....

Remark's :

21

Twenty One



Say, Trace and Write.

21	21	21	21	21	21	21	
21	21	21	21	21	21		
21	21	21	21	21			
21	21	21	21				
21	21	21					
21	21						
21							

Date :/...../.....

Remark's :

22

Twenty Two



Say, Trace and Write.

22	22	22	22	22	22	22	
22	22	22	22	22	22		
22	22	22	22	22			
22	22	22	22				
22	22	22					
22	22						
22							

Date :/...../.....

Remark's :

23

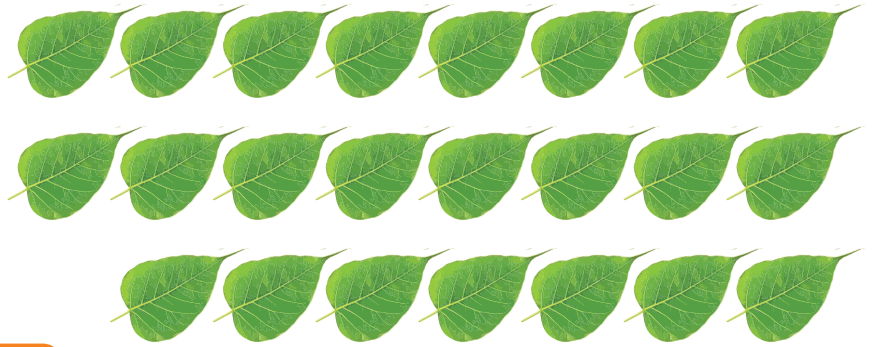

Twenty Three

Say, Trace and Write.

23	23	23	23	23	23	23	
23	23	23	23	23	23		
23	23	23	23	23			
23	23	23	23				
23	23	23					
23	23						
23							

Date :/...../.....

Remark's :

24



Twenty Four

Say, Trace and Write.

24	24	24	24	24	24	24	
24	24	24	24	24	24		
24	24	24	24	24			
24	24	24	24				
24	24	24					
24	24						
24							

Date :/...../.....

Remark's :

25

Twenty Five

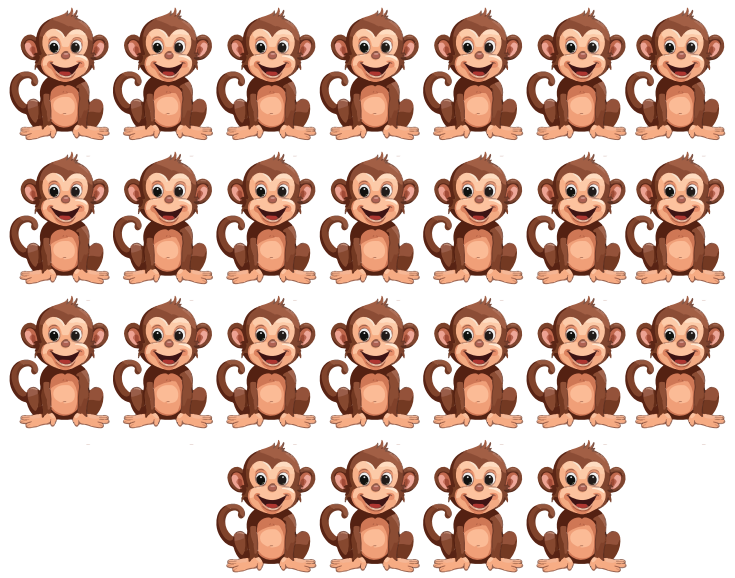

Say, Trace and Write.

25	25	25	25	25	25	25	
25	25	25	25	25	25		
25	25	25	25	25			
25	25	25	25				
25	25	25					
25	25						
25							

Date :/...../.....

Remark's :

26

Twenty Six

Say, Trace and Write.

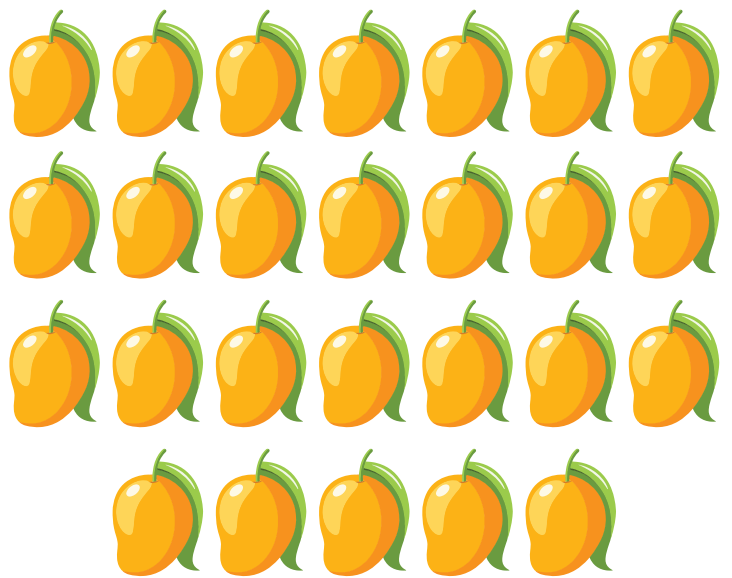

26	26	26	26	26	26	26	
26	26	26	26	26	26		
26	26	26	26	26			
26	26	26	26				
26	26						
26							

Date :/...../.....

Remark's :

27



Twenty Seven

Say, Trace and Write.

27	27	27	27	27	27	27	
27	27	27	27	27	27		
27	27	27	27	27			
27	27	27	27				
27	27	27					
27	27						
27							

Date :/...../.....

Remark's :

28



Twenty Eight



Say, Trace and Write.

28	28	28	28	28	28	28	
28	28	28	28	28	28		
28	28	28	28	28			
28	28	28	28				
28	28	28					
28	28						
28							

Date :/...../.....

Remark's :



★ **Twenty Nine** ★

Say, Trace and Write.

29	29	29	29	29	29	29	
29	29	29	29	29	29		
29	29	29	29	29			
29	29	29	29				
29	29	29					
29	29						
29							

30

Thirty



Say, Trace and Write.

30	30	30	30	30	30	30	
30	30	30	30	30	30		
30	30	30	30	30			
30	30	30	30				
30	30	30					
30	30						
30							

Date :/...../.....

Remark's :

PRACTICE WORKSHEET

Q.1). Write the missing numbers from 11 To 30

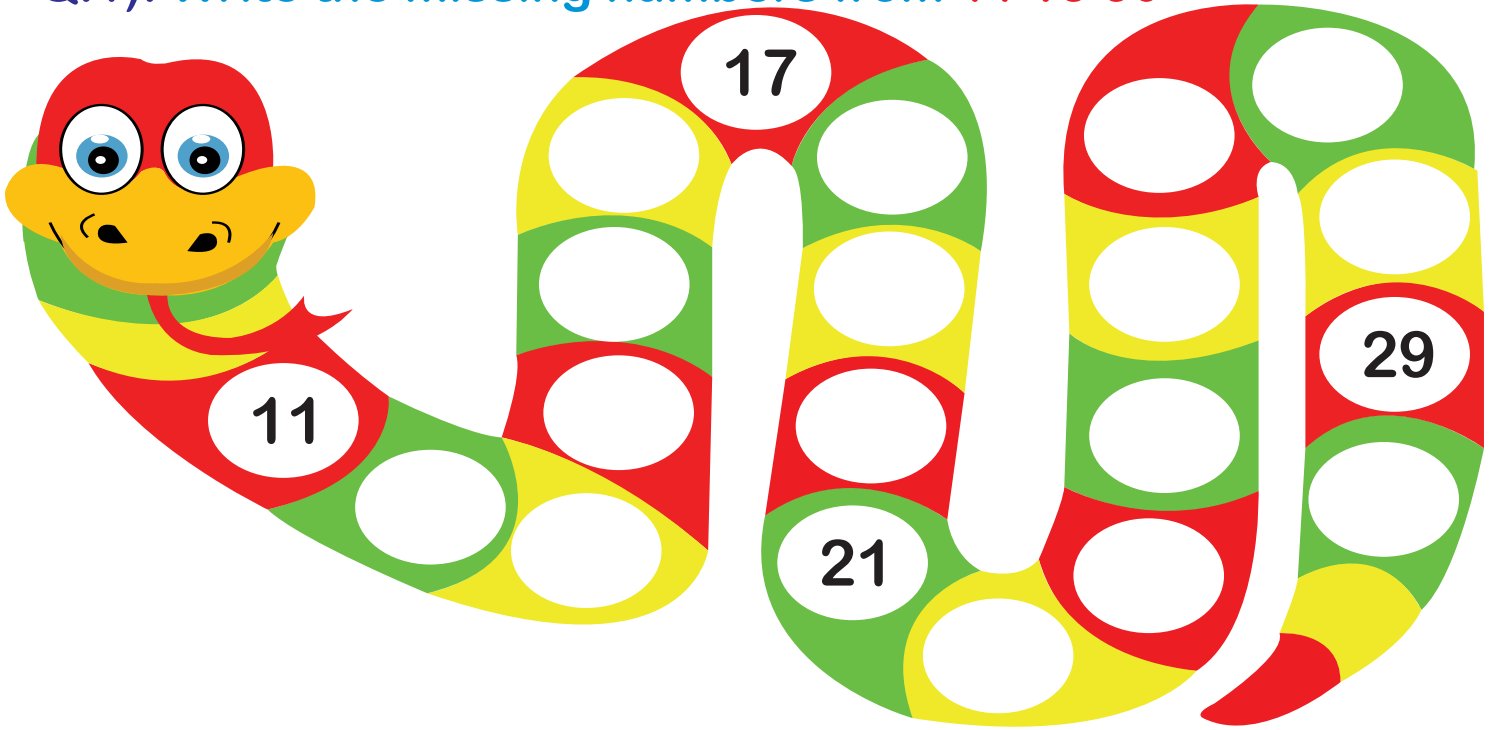

Q.2). Trace the number names using different crayons and write the numbers.

Twenty-One = 

Twenty-Seven = 

Twenty-Six = 

Twenty-Two = 

Thirty = 

Twenty-Nine = 

PRACTICE WORKSHEET

Q.3). Identify the number names and color that number in same colour.

Twenty-Three, Twenty-Five, Twenty-Seven,
Twenty-Two, Thirty.

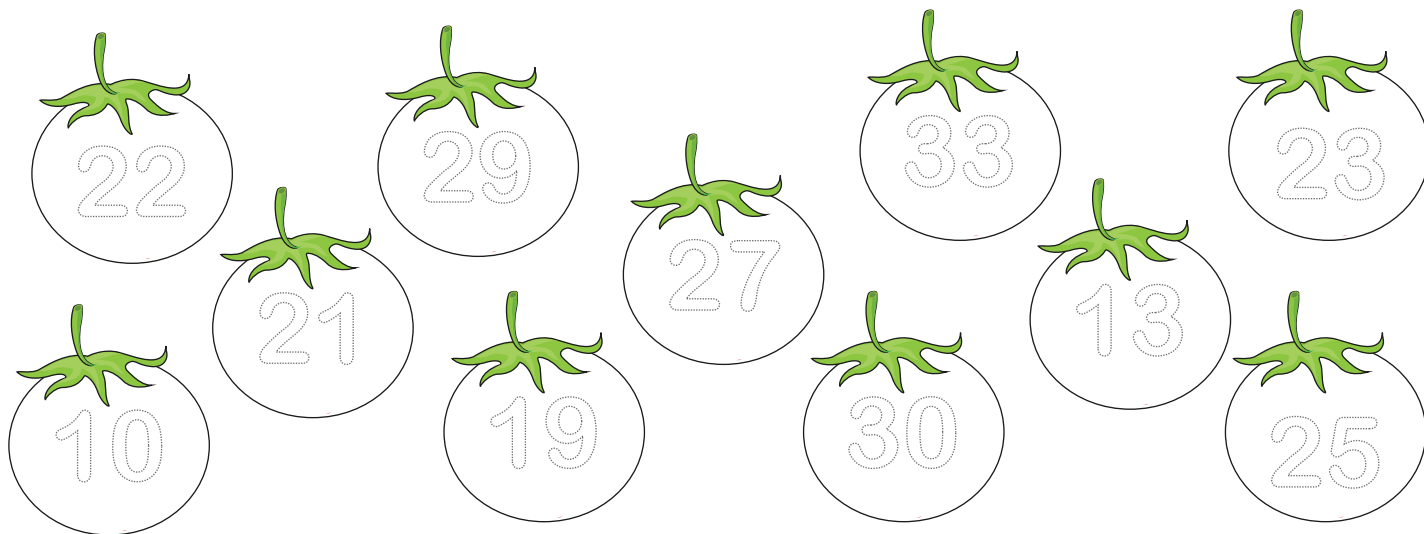

Q.4). Write the between numbers.

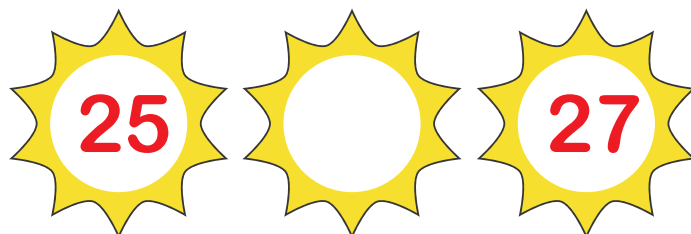
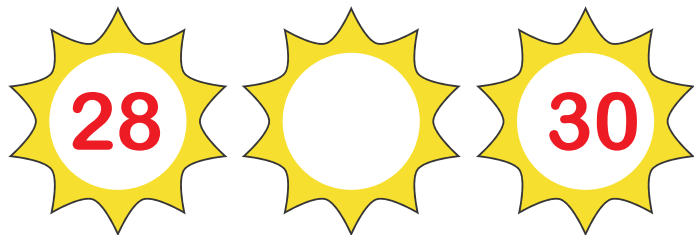
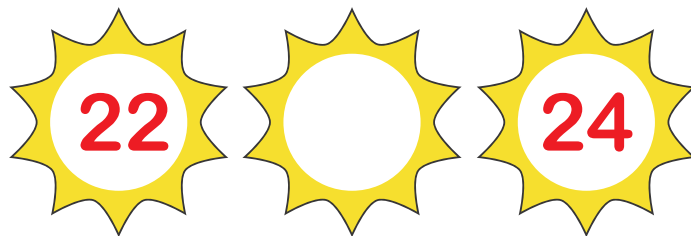
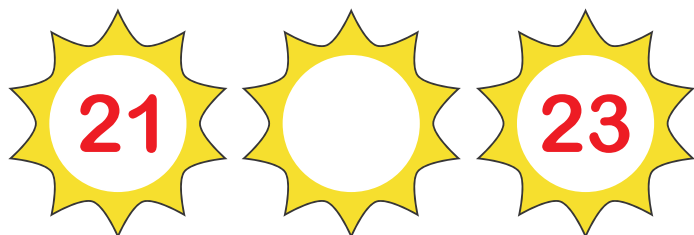



PRACTICE WORKSHEET

Q.5). Connect the dots and colour the picture.

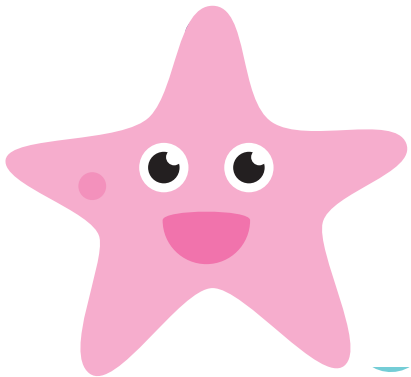
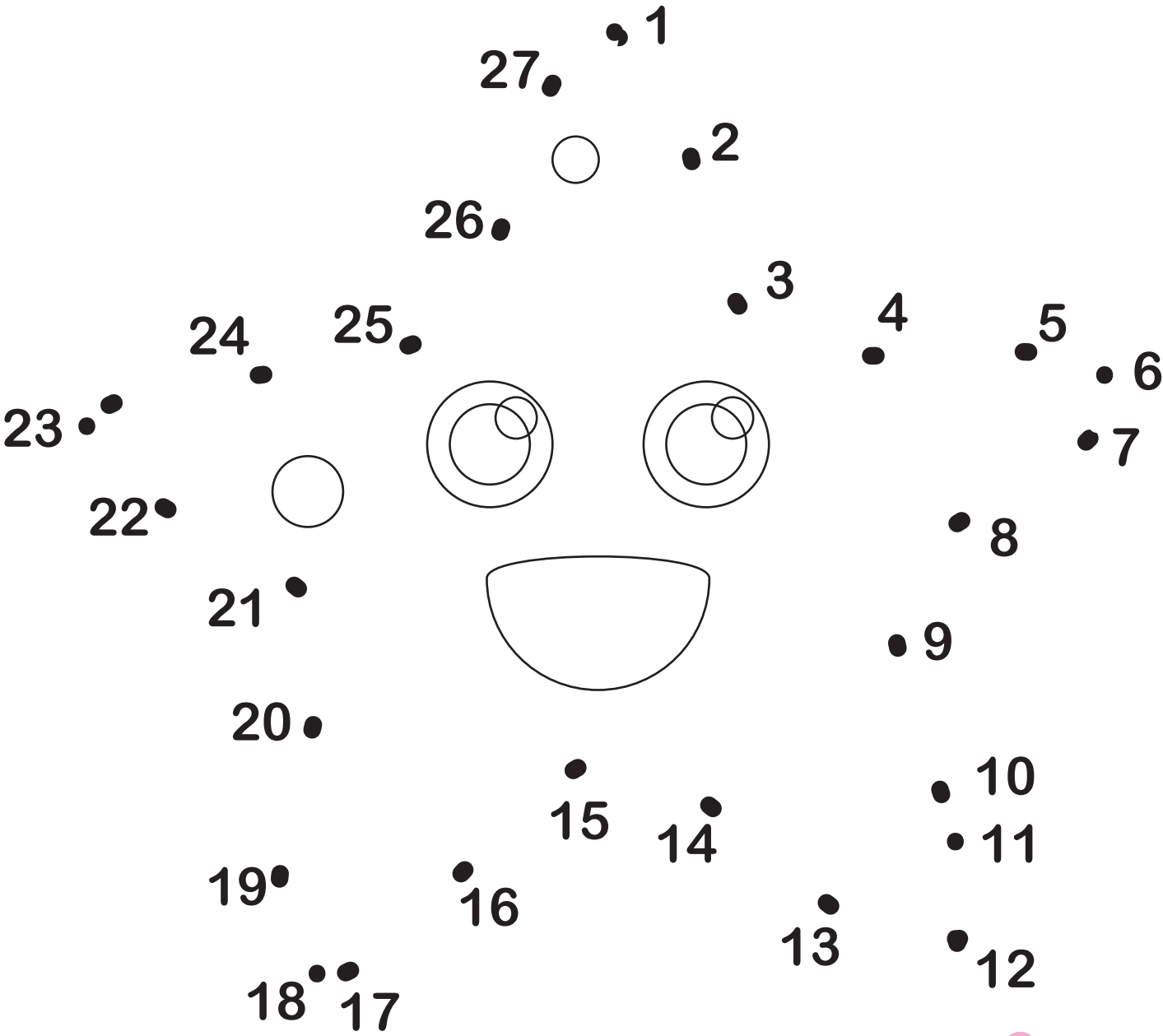

Date :/...../.....

Remark's :

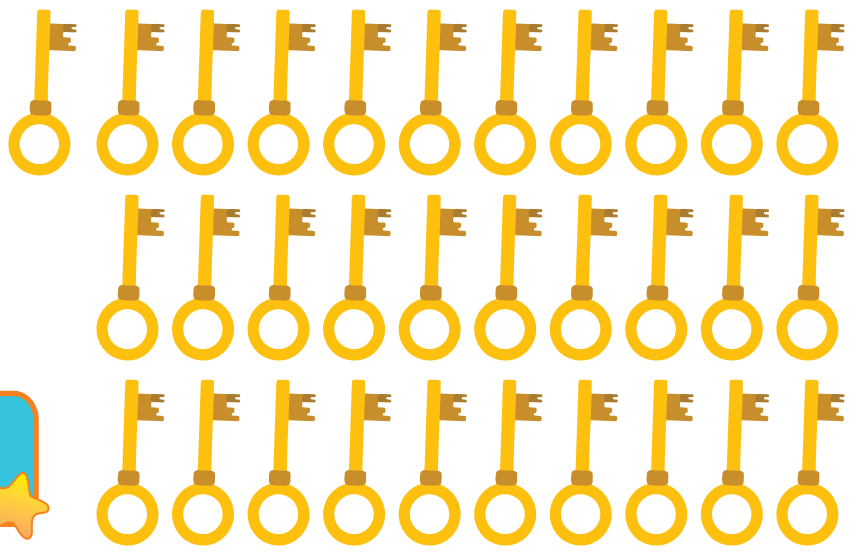

Say, Trace and Write.

31	31	31	31	31	31	31	
31	31	31	31	31	31		
31	31	31	31	31			
31	31	31	31				
31	31	31					
31	31						
31							

Date :/...../.....

Remark's :

32

Thirty Two

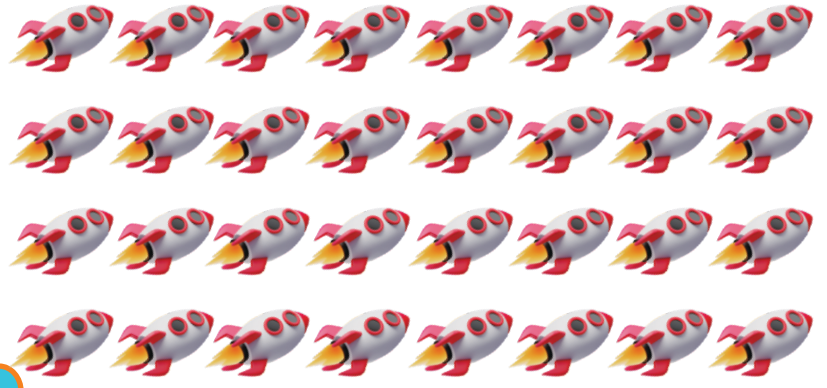

Say, Trace and Write.

32	32	32	32	32	32	32	
32	32	32	32	32	32		
32	32	32	32	32			
32	32	32	32				
32	32	32					
32	32						
32							

Date :/...../.....

Remark's :

33

Thirty Three

Say, Trace and Write.

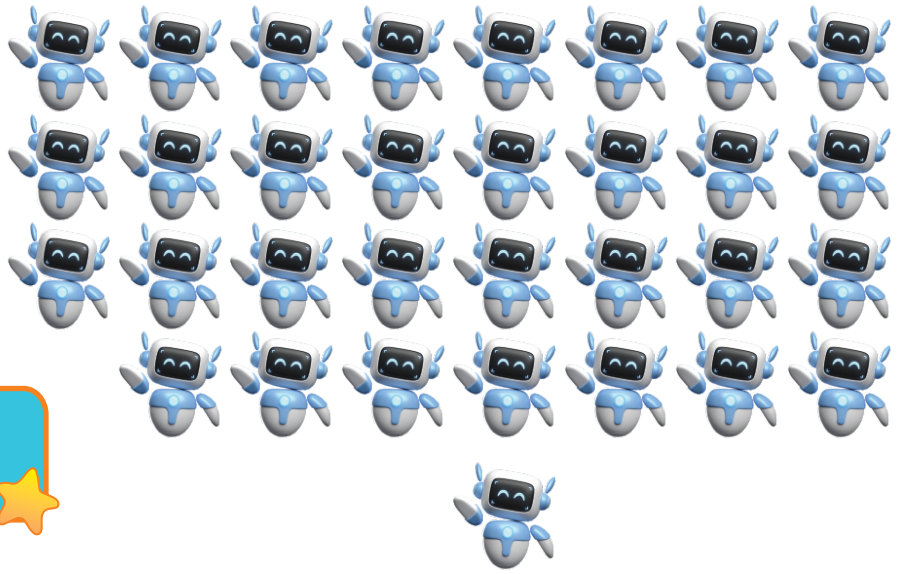

33	33	33	33	33	33	33	
33	33	33	33	33	33		
33	33	33	33	33			
33	33	33	33				
33	33	33					
33	33						
33							

Date :/...../.....

Remark's :

34

Thirty Four

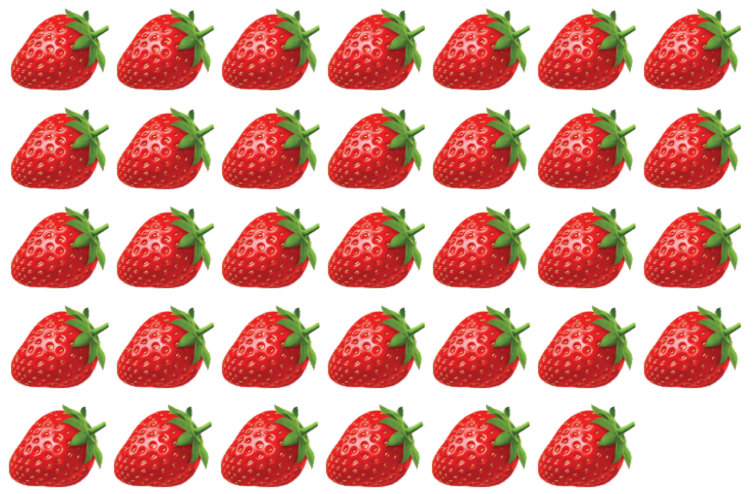

Say, Trace and Write.

34	34	34	34	34	34	34	
34	34	34	34	34	34		
34	34	34	34	34			
34	34	34	34				
34	34	34					
34	34						
34							

Date :/...../.....

Remark's :

35

Thirty Five

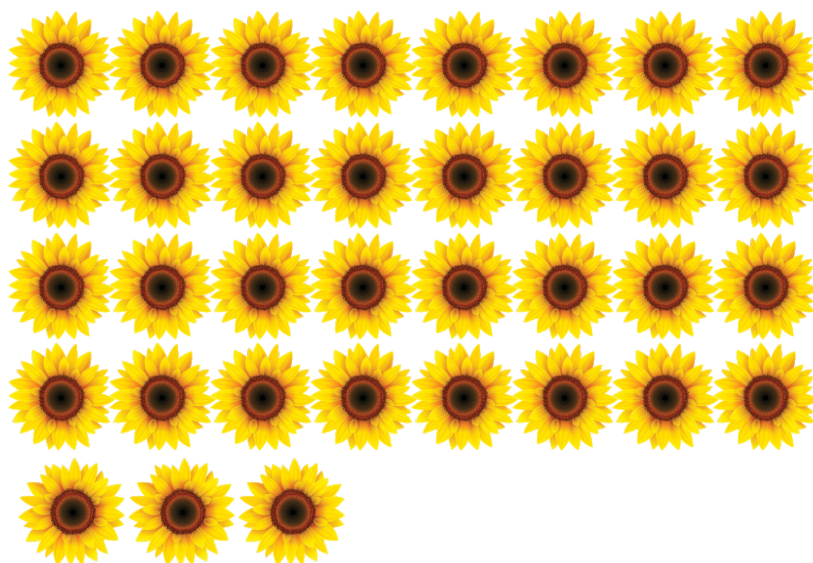

Say, Trace and Write.

35	35	35	35	35	35	35	
35	35	35	35	35	35		
35	35	35	35	35			
35	35	35	35				
35	35	35					
35	35						
35							

Date :/...../.....

Remark's :

36

Thirty Six

Say, Trace and Write.

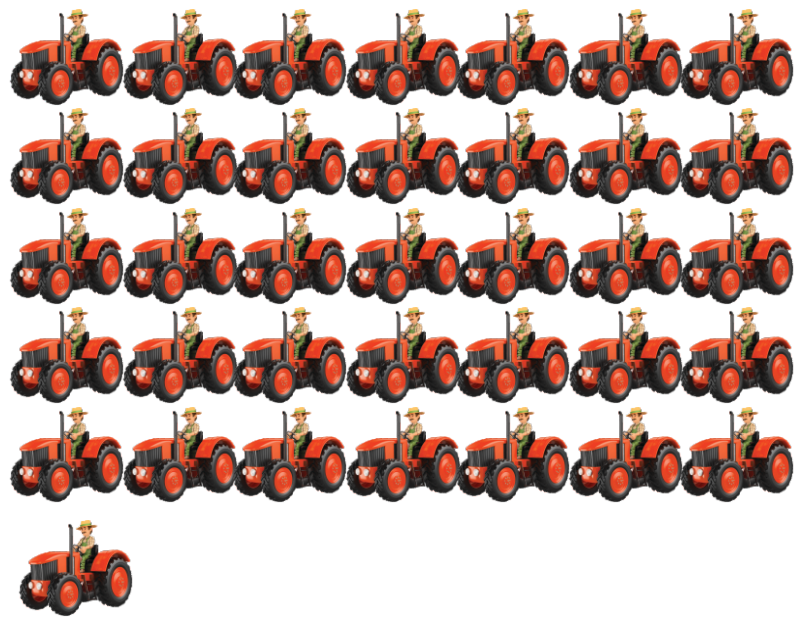

36	36	36	36	36	36	36	
36	36	36	36	36	36		
36	36	36	36	36			
36	36	36	36				
36	36	36					
36	36						
36							

Date :/...../.....

Remark's :

37

Thirty Seven

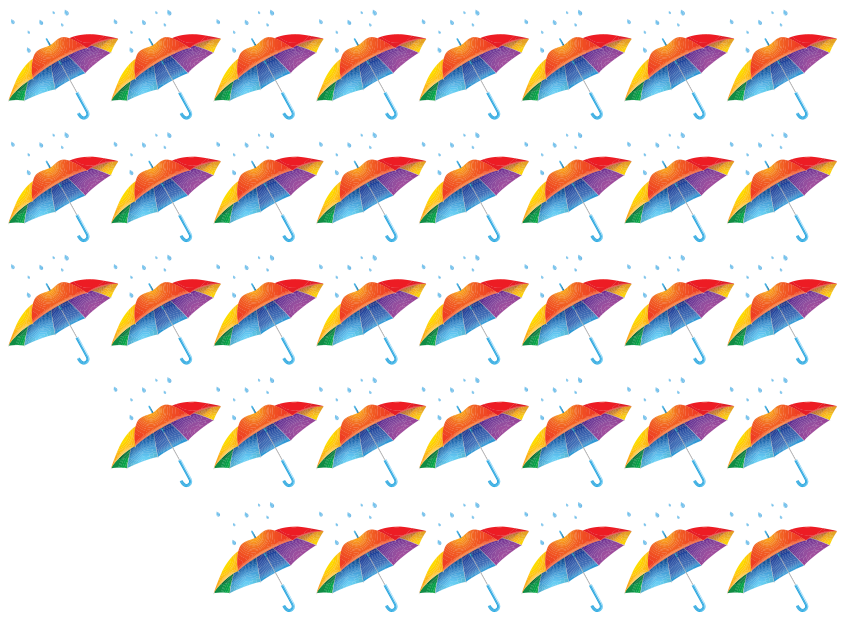

Say, Trace and Write.

37	37	37	37	37	37	37	
37	37	37	37	37	37		
37	37	37	37	37			
37	37	37	37				
37	37	37					
37	37						
37							

Date :/...../.....

Remark's :

38

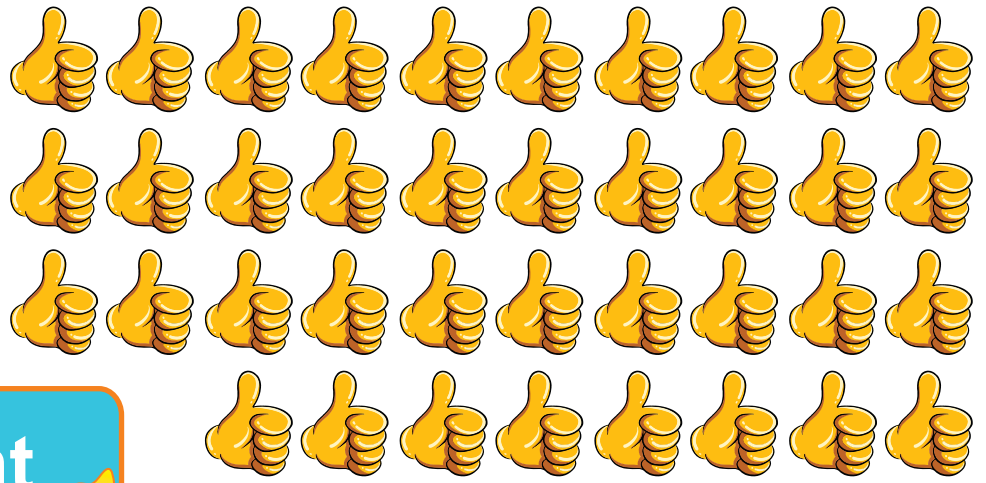

Thirty Eight

Say, Trace and Write.

38	38	38	38	38	38	38	
38	38	38	38	38	38		
38	38	38	38	38			
38	38	38	38				
38	38	38					
38	38						
38							

Date :/...../.....

Remark's :

39

Thirty Nine

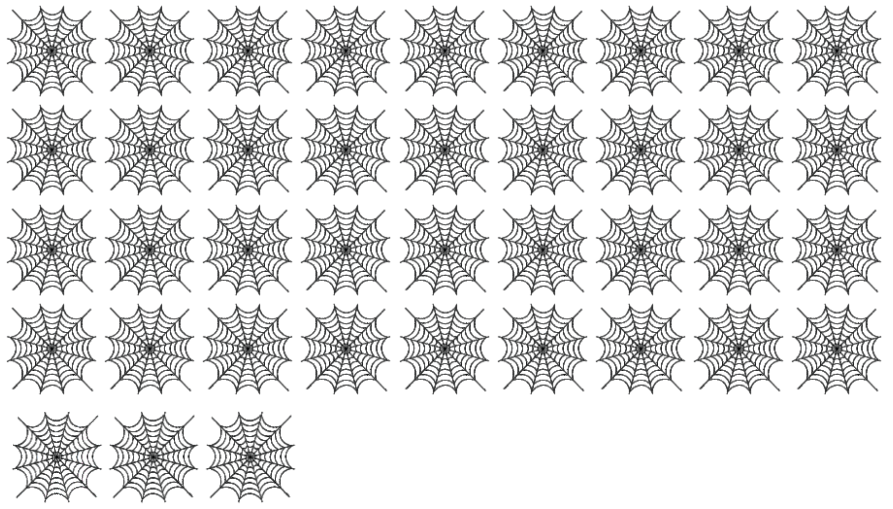

Say, Trace and Write.

39	39	39	39	39	39	39	
39	39	39	39	39	39		
39	39	39	39	39			
39	39	39	39				
39	39	39					
39	39						
39							

Date :/...../.....

Remark's :

40

Forty

Say, Trace and Write.

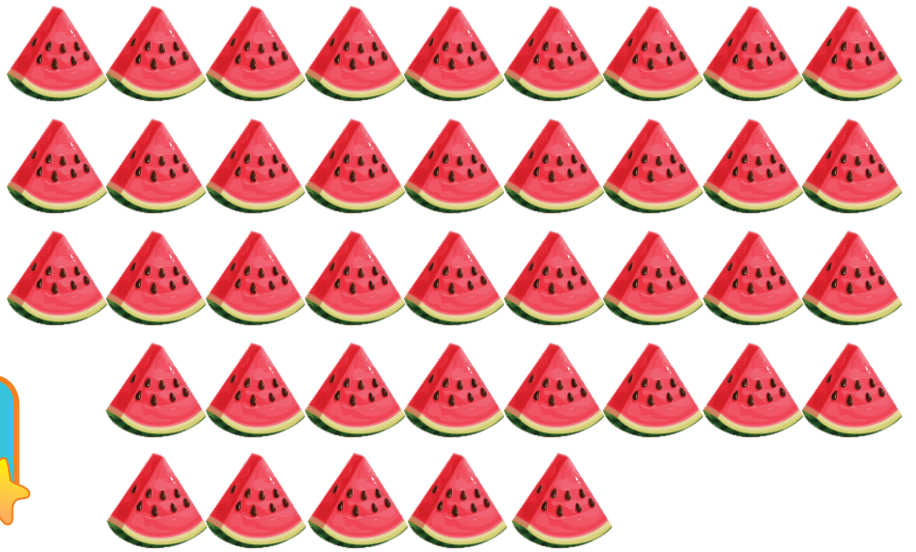

40	40	40	40	40	40	40	
40	40	40	40	40	40		
40	40	40	40	40			
40	40	40	40				
40	40						
40							

Date :/...../.....

Remark's :

PRACTICE WORKSHEET

Q.1). Write the missing numbers between 21 To 40

21

26

31

40

Q.2). Guess and write the correct numbers below.

Thirty-Three =

Forty =

Thirty-One =

Thirty-six =

Thirty-Two =

Thirty-Five =

PRACTICE WORKSHEET

Q.3). Identify the numbers and colour their number name is same colour.

24 28 22 27 30

Twenty-Eight

Twenty-Six

Twenty-Nine

Twenty-One

Twenty-Two

Twenty-Four

Thirty

Twenty-Seven

Q.4). Write the after numbers.

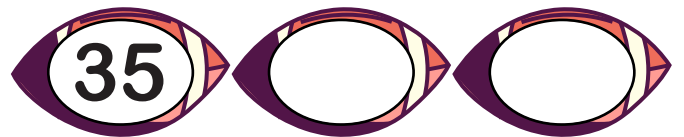
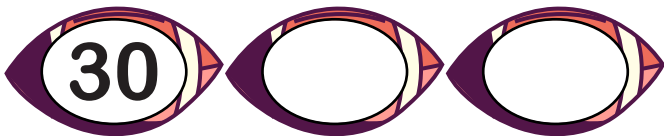

Q.5). Write the before numbers.

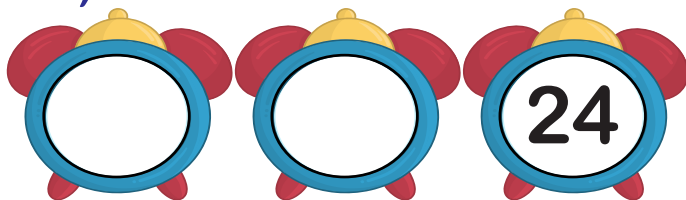

PRACTICE WORKSHEET

Q.5). Connect the dots and colour the picture.

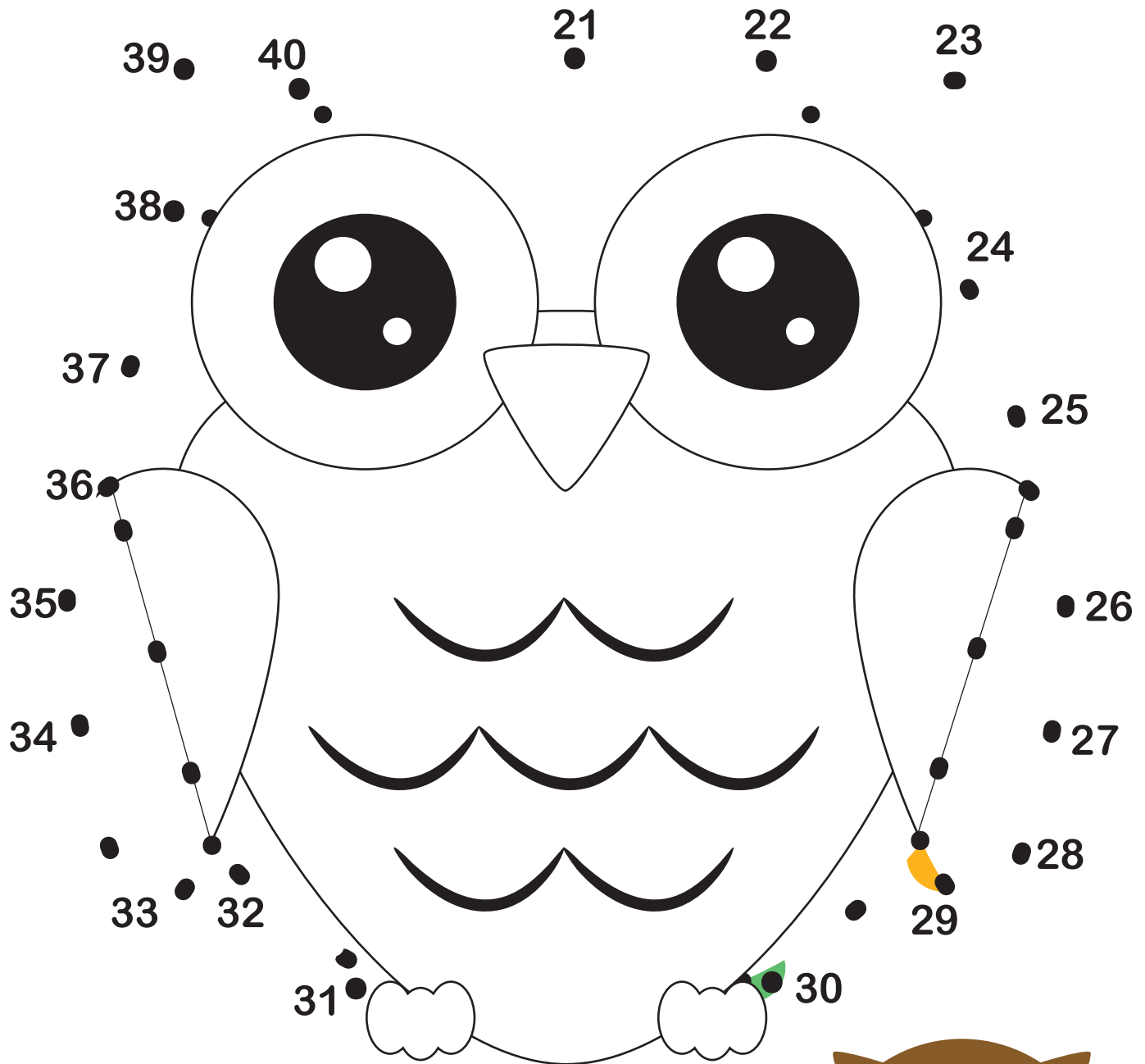

Date :/...../.....

Remark's :

41

Forty One

Say, Trace and Write.

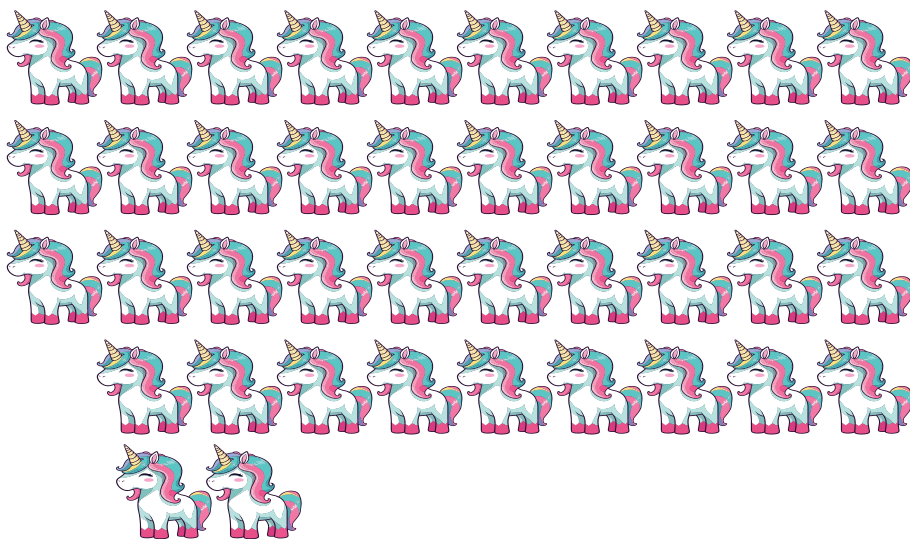

41	41	41	41	41	41	41	
41	41	41	41	41	41		
41	41	41	41	41			
41	41	41	41				
41	41	41					
41	41						
41							

Date :/...../.....

Remark's :

42

Forty Two

Say, Trace and Write.



42	42	42	42	42	42	42	
42	42	42	42	42	42		
42	42	42	42	42			
42	42	42	42				
42	42	42					
42	42						
42							

43

Forty Three

Say, Trace and Write.



43	43	43	43	43	43	43	
43	43	43	43	43	43		
43	43	43	43	43			
43	43	43	43				
43	43	43					
43	43						
43							

Date :/...../.....

Remark's :

44

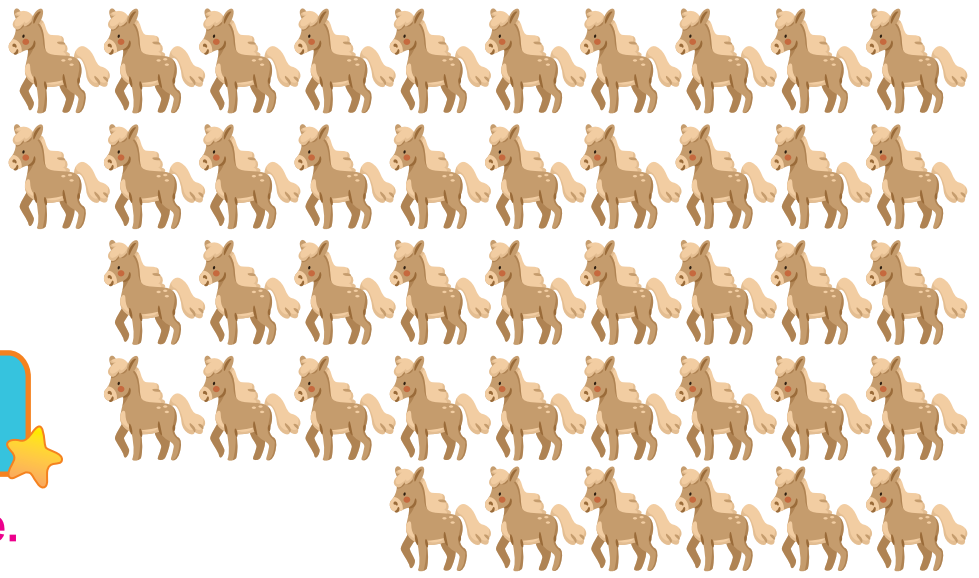

Forty Four

Say, Trace and Write.

44	44	44	44	44	44	44	
44	44	44	44	44	44		
44	44	44	44	44			
44	44	44	44				
44	44	44					
44	44						
44							

45

Forty Five

Say, Trace and Write.

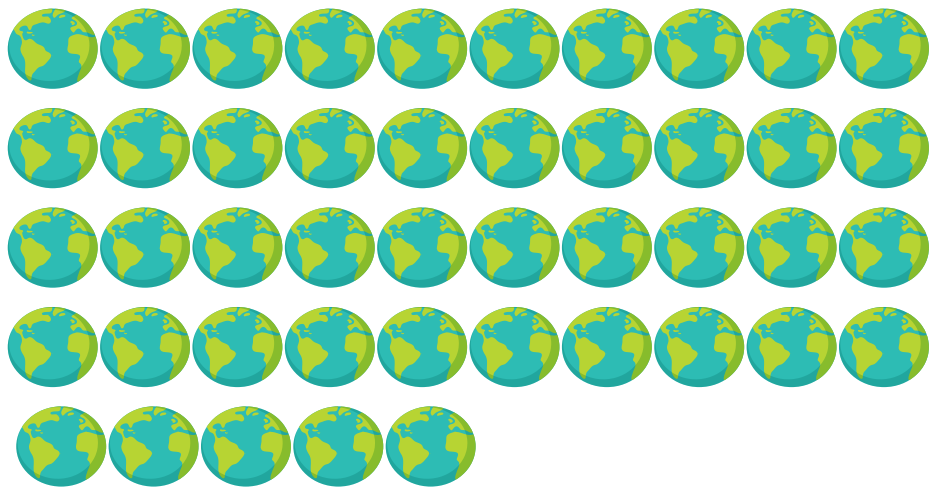

45	45	45	45	45	45	45	
45	45	45	45	45	45		
45	45	45	45	45			
45	45	45	45				
45	45	45					
45	45						
45							

46

Forty Six

Say, Trace and Write.

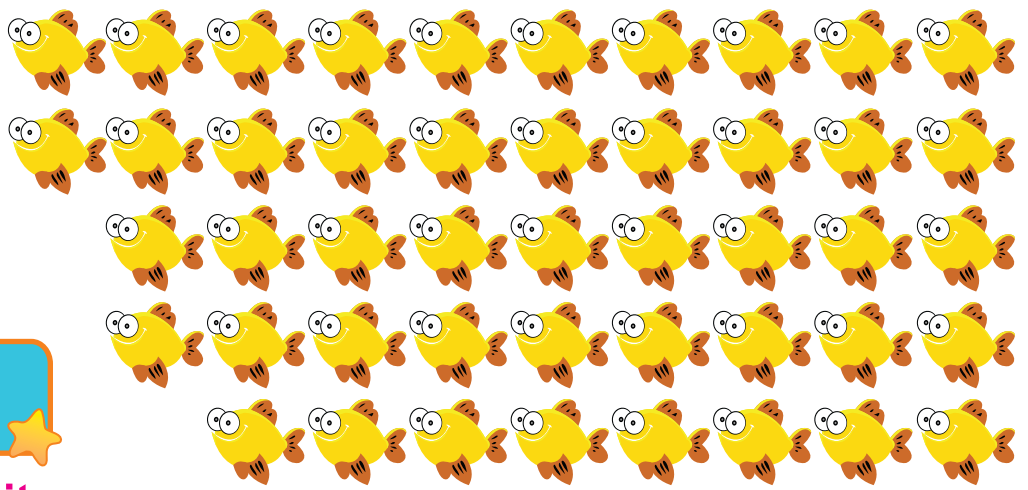

46	46	46	46	46	46	46	
46	46	46	46	46	46		
46	46	46	46	46			
46	46	46	46				
46	46	46					
46	46						
46							

Date :/...../.....

Remark's :

47

Forty Seven

Say, Trace and Write.



47	47	47	47	47	47	47	
47	47	47	47	47	47		
47	47	47	47	47			
47	47	47	47				
47	47	47					
47	47						
47							

Date :/...../.....

Remark's :

48

Forty Eight

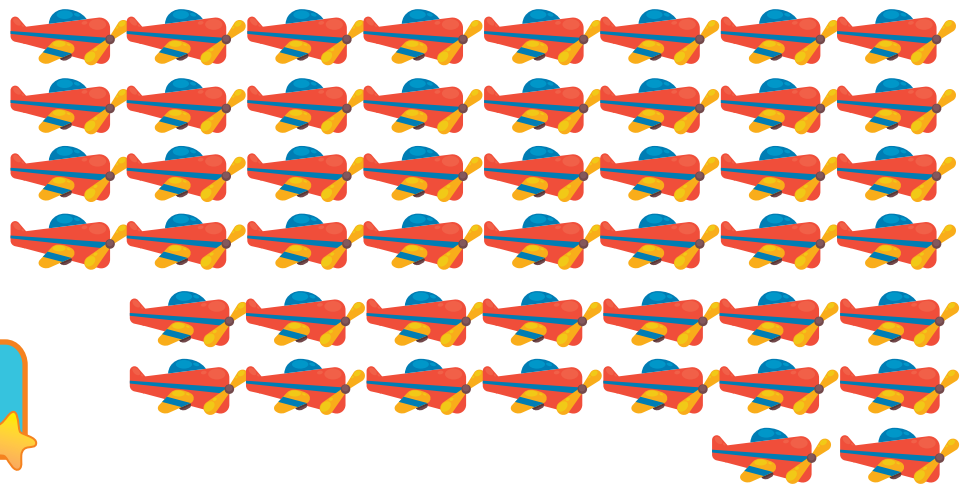

Say, Trace and Write.

48	48	48	48	48	48	48	
48	48	48	48	48	48		
48	48	48	48	48			
48	48	48	48				
48	48	48					
48	48						
48							

Date :/...../.....

Remark's :

49

Forty Nine

Say, Trace and Write.

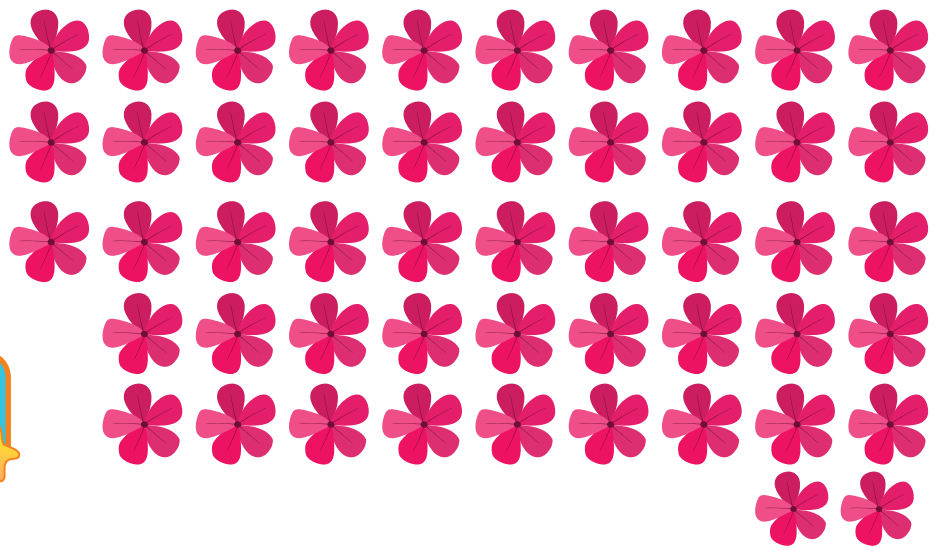

49	49	49	49	49	49	49	
49	49	49	49	49	49		
49	49	49	49	49			
49	49	49	49				
49	49	49					
49	49						
49							

50

Fifty



Say, Trace and Write.

50	50	50	50	50	50	50	
50	50	50	50	50	50		
50	50	50	50	50			
50	50	50	50				
50	50	50					
50	50						
50							

Date :/...../.....

Remark's :

PRACTICE WORKSHEET

Q.1). Write the missing numbers between 41 To 50

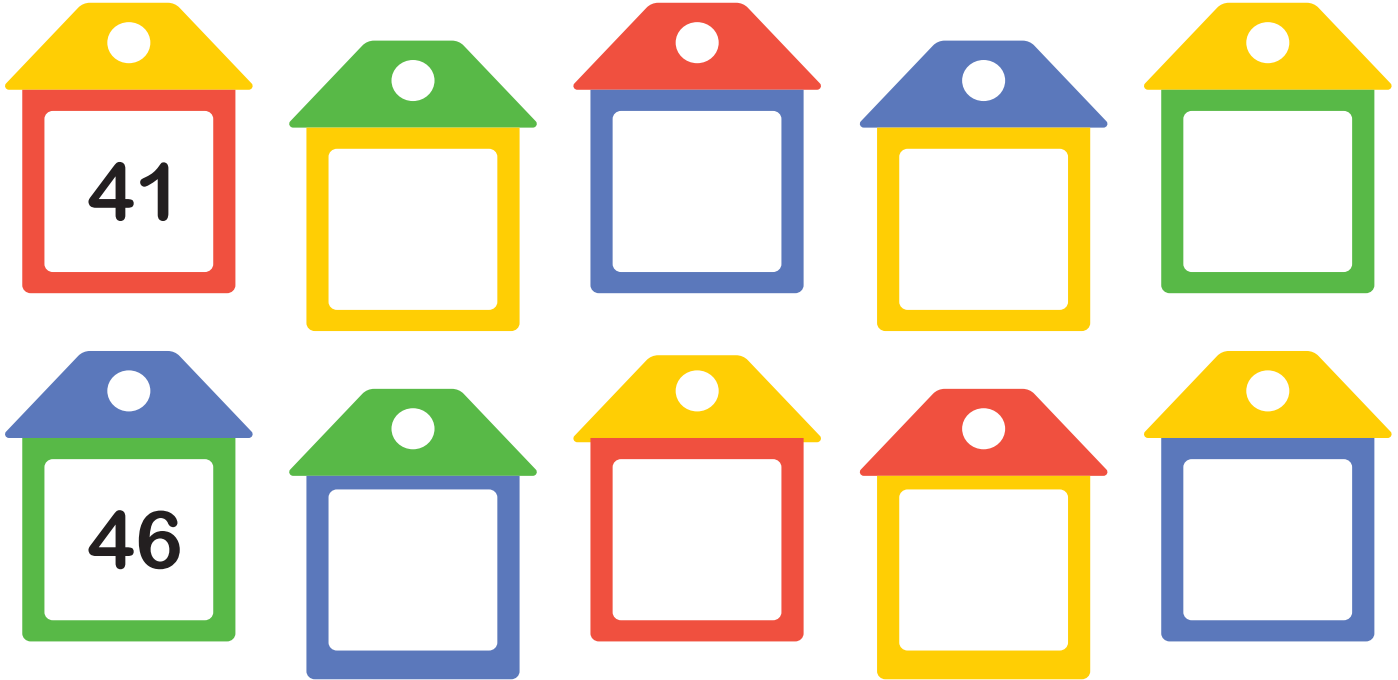

Q.2). Write the after numbers.

48		
----	--	--

41		
----	--	--

Q.3). Write the before numbers.

		50
--	--	----

		43
--	--	----

Q.4). Write the between numbers.

44		46
----	--	----

41		43
----	--	----



PRACTICE WORKSHEET

Q.5). Drag letters to complete the spell words of numbers.

45 F__rt__ - F__ve

48 Fo__r t__ - E i__ht

44 F__r__y - Fo__r

43 Fo__ty - Thr__e

46 T__e__ty - Si__

Q.6). Encircle the number between 41 To 50

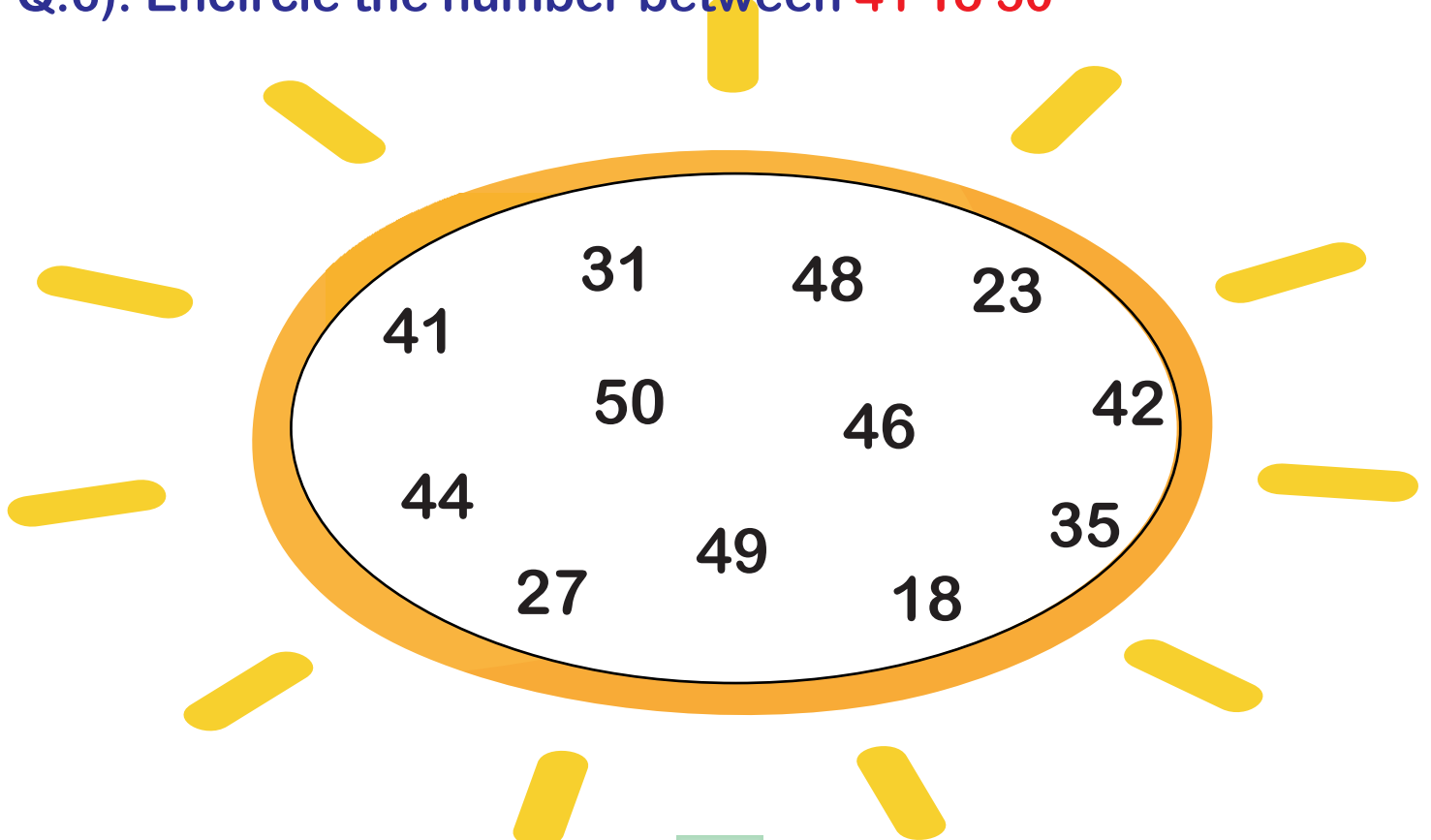

Date :/...../.....

Remark's :

PRACTICE WORKSHEET

Q.5). Connect the dots and colour the picture.

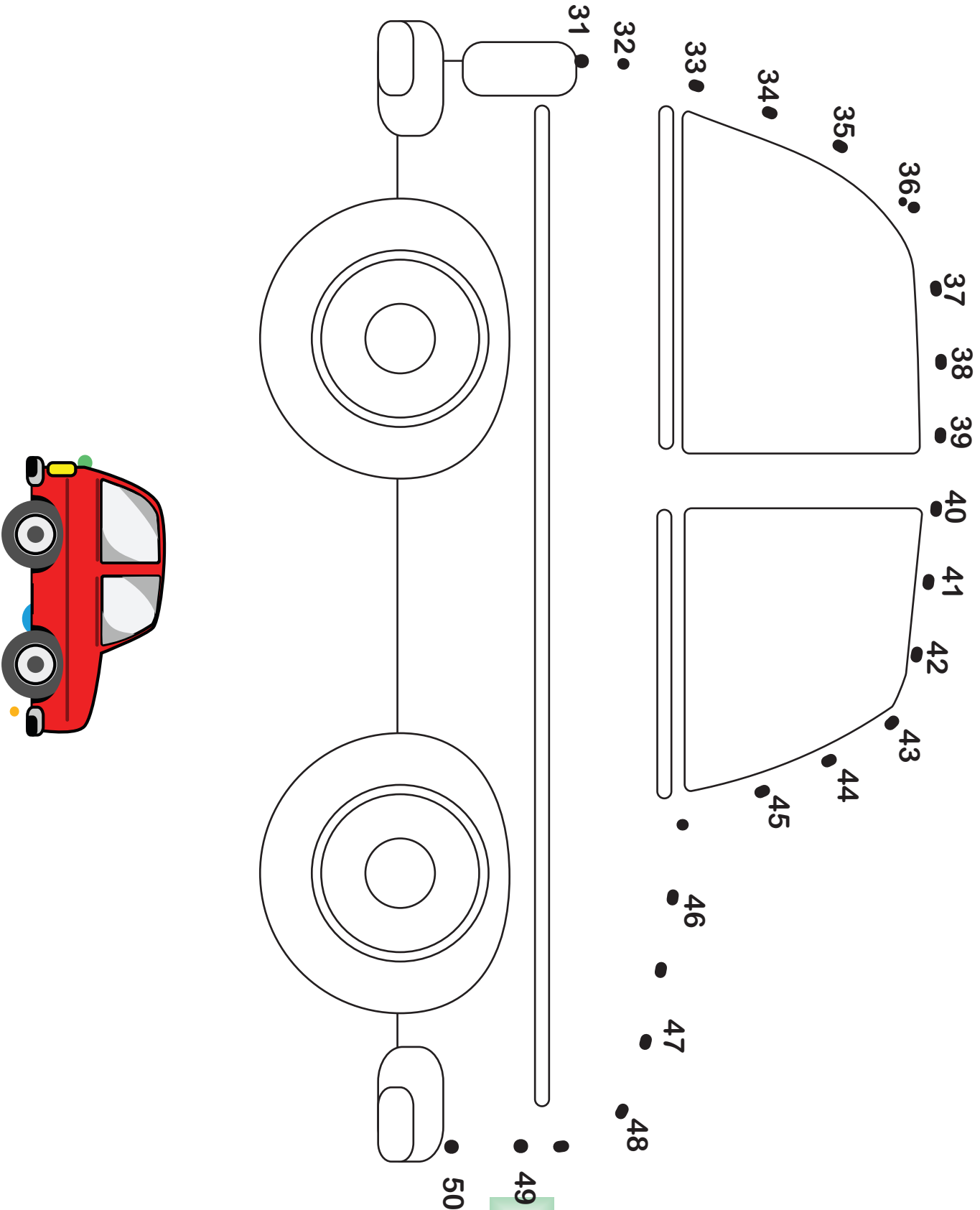

Date :/...../.....

Remark's :



Write the numbers from 1 To 50

1

11

21

31

41

Date :/...../.....

Remark's :



Google Play



TIMELY PUBLICATIONS

Near Naik Wada, Naik Road,
Mahal, Nagpur. 440032

E-mail : timelypublications@gmail.com
www.timelypublication.com

- **Book Design By** : Shivali A. Puri
- **Printed by** : Sanjay Offset, New Shukrawari, Nagpur.
- **Revised Edition** : 2026

© All Rights Reserved with Publisher.

All Books are Available at :
•Mumbai •Ahmadabad •Hyderabad •Delhi •Bhopal.

ISBN 978-81-933713-8-1



9 788193 371381

₹ 199.00