



CRAYONS MAGIC



TIMELY PUBLICATION





TIMELY PUBLICATION



Kil-Bil
SERIES



CRAYONS MAGIC



My name is

I am years old.

I am in standard

My school name is.....

.....



By Mrs. Vaishnavi S. Giri

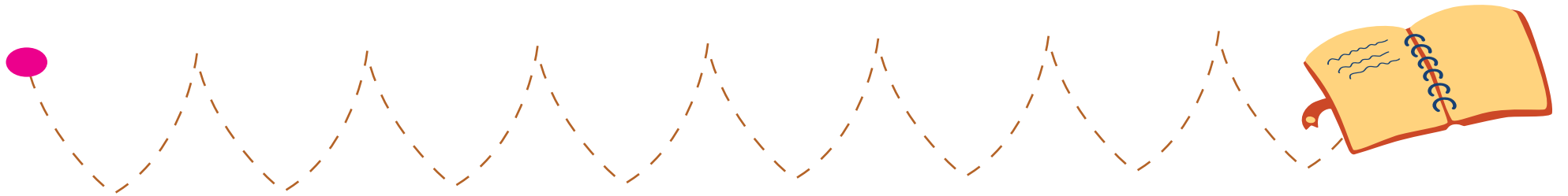
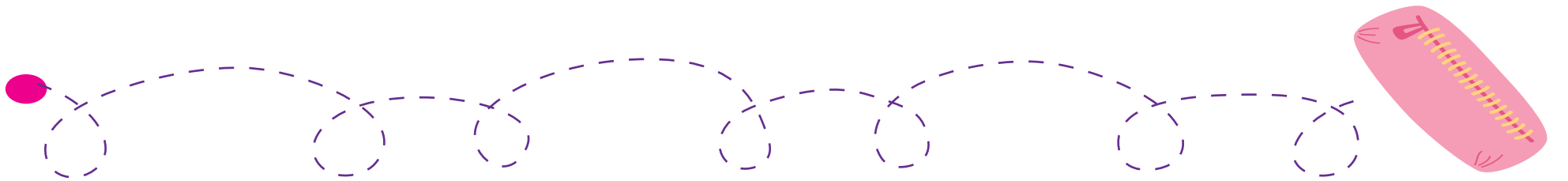
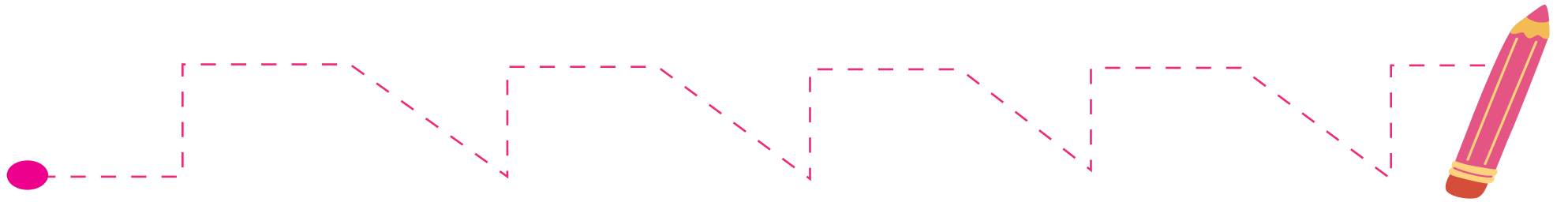
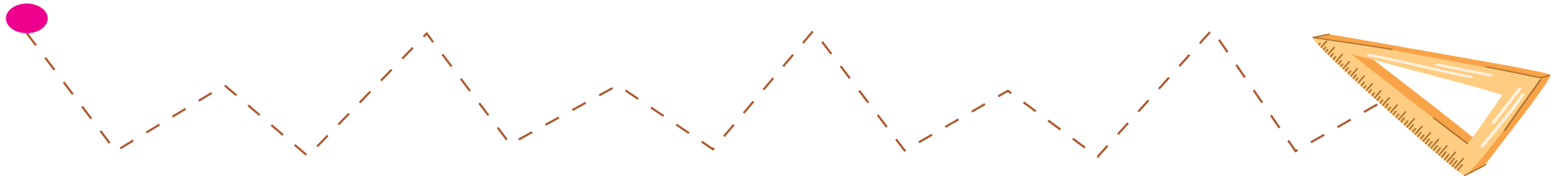
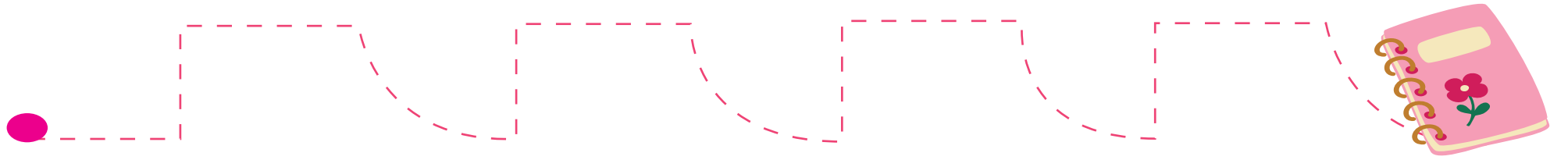

Colour the path :

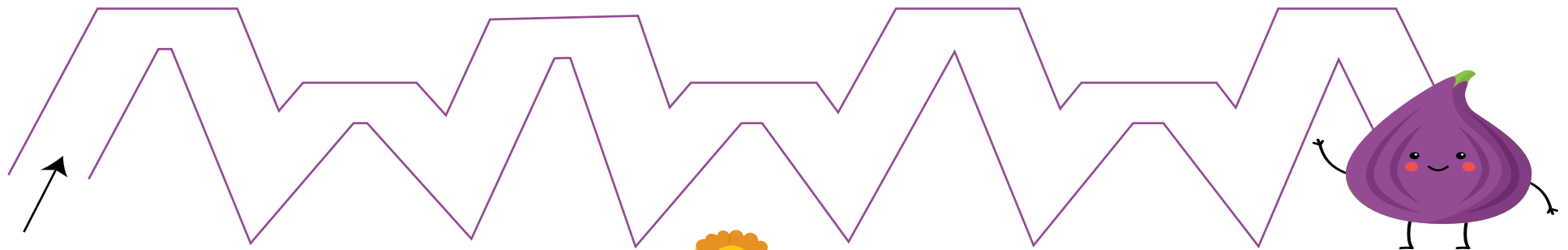
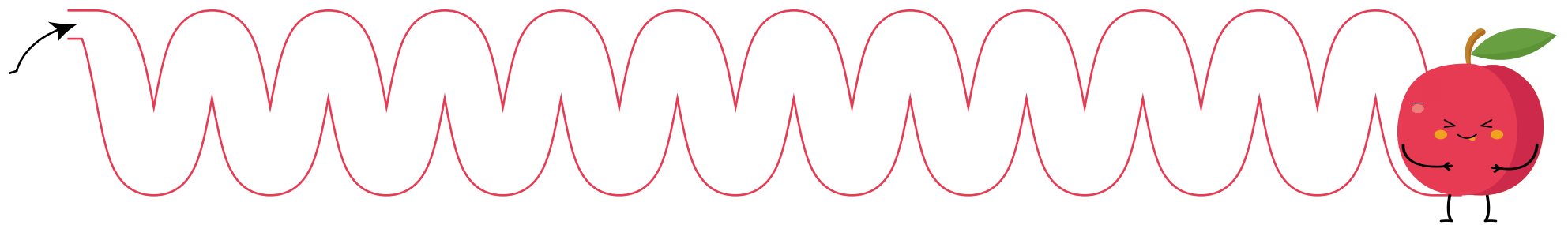
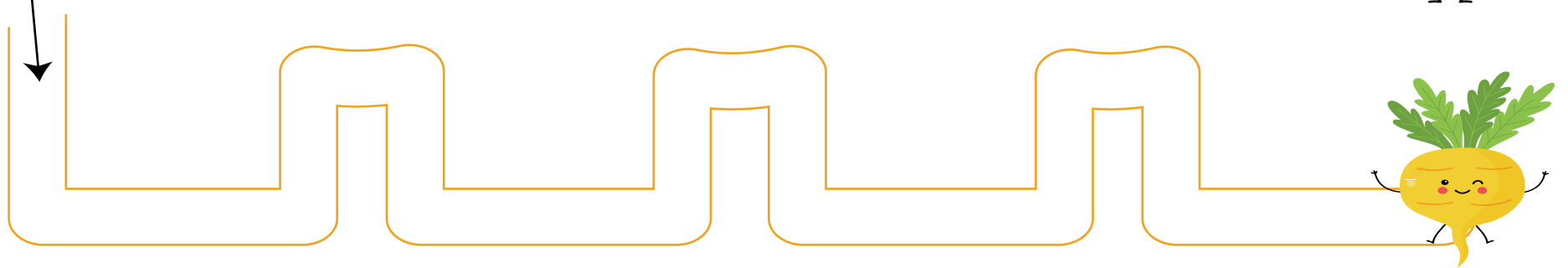
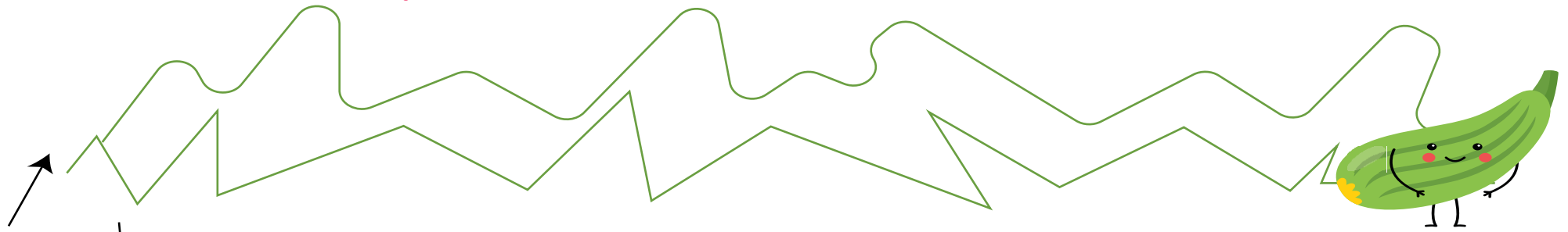

Connect the dots and colour the picture.

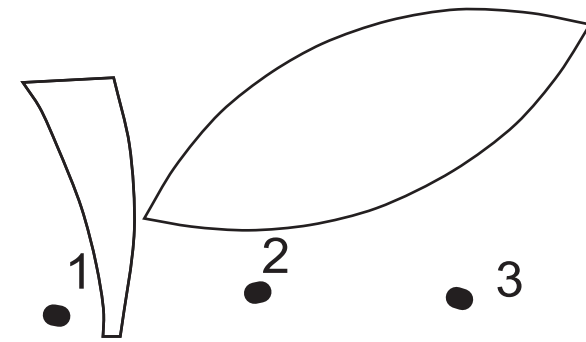
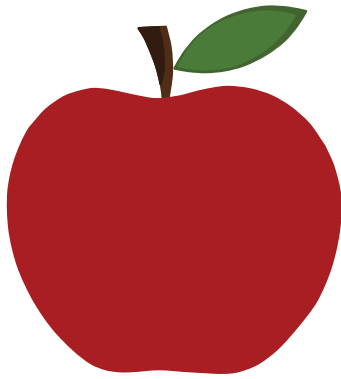

Activity :

1. Identify the picture ?

Ans : _____
(Orange / Apple)

2. What is the colour of the picture ?

Ans : _____
(Red / Green)

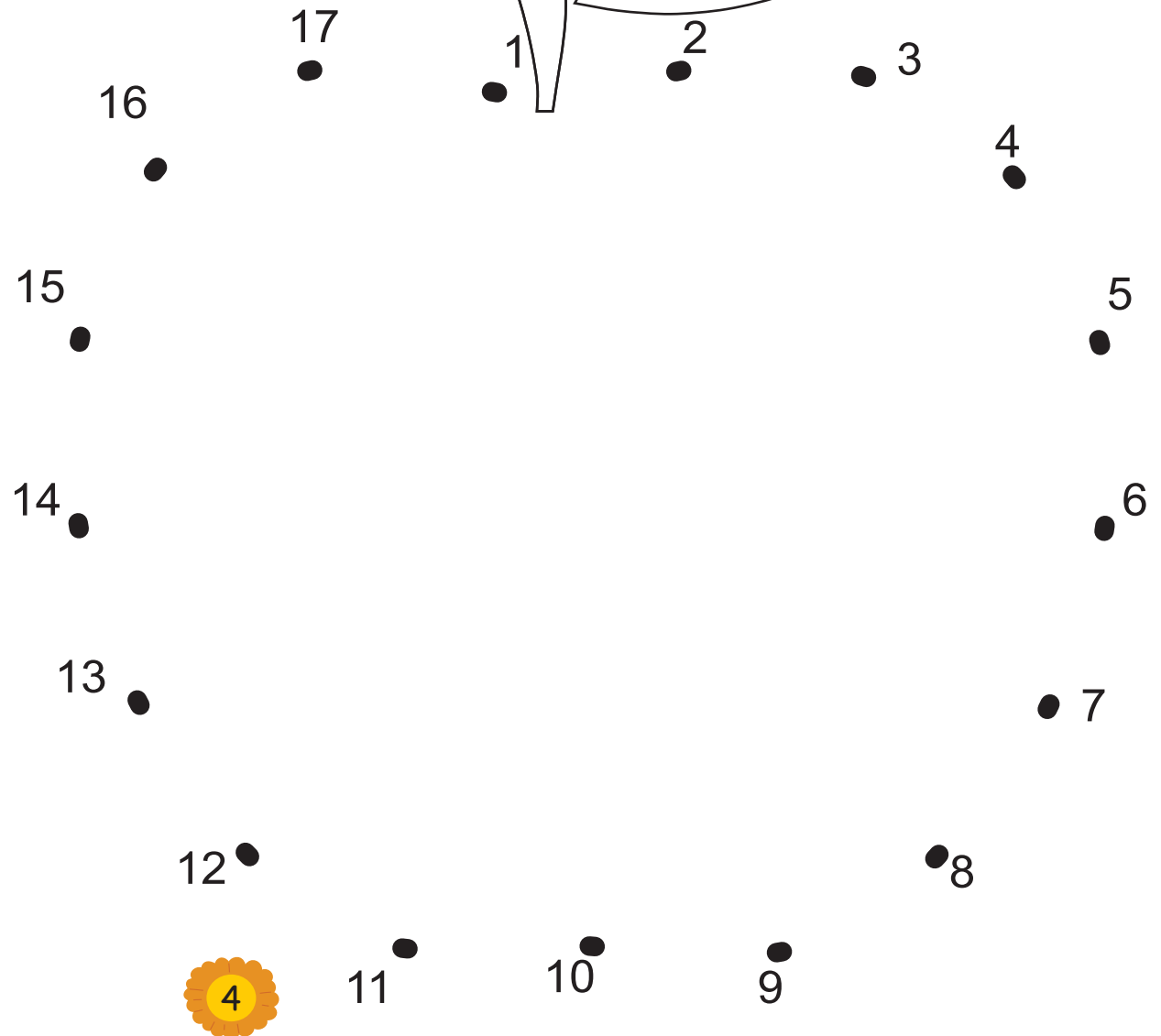

Connect the dots and colour the picture.

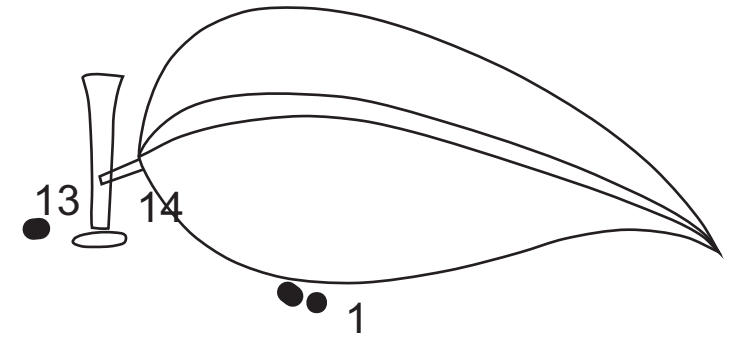
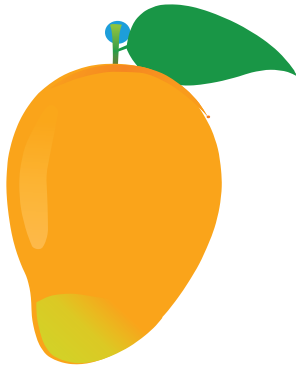

Activity :

1. Identify the picture ?

Ans : _____
(Papaya / Mango)

2. What is the colour of the picture ?

Ans : _____
(Green / Orange)

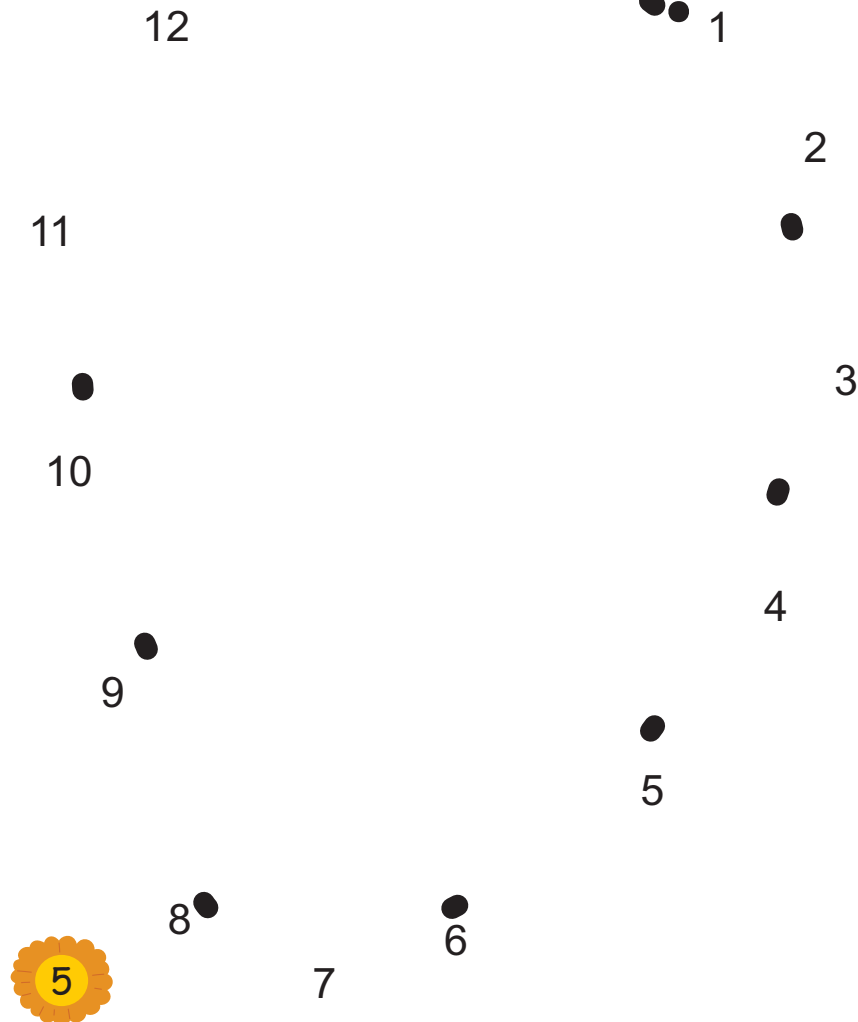

Connect the dots and colour the picture.

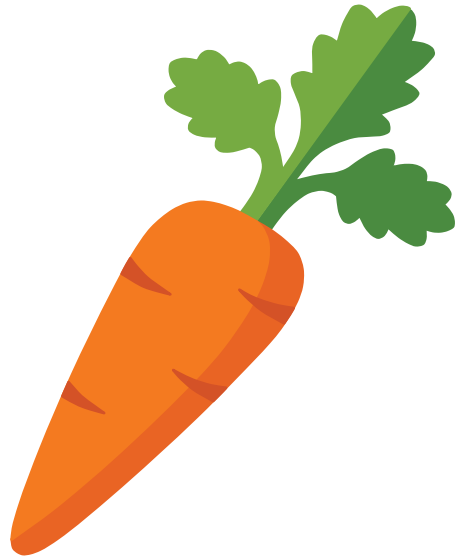

Activity :

1. Identify the picture ?

Ans : _____
(Carrot / Raddish)

2. What is the colour of the picture ?

Ans : _____
(Orange / White)

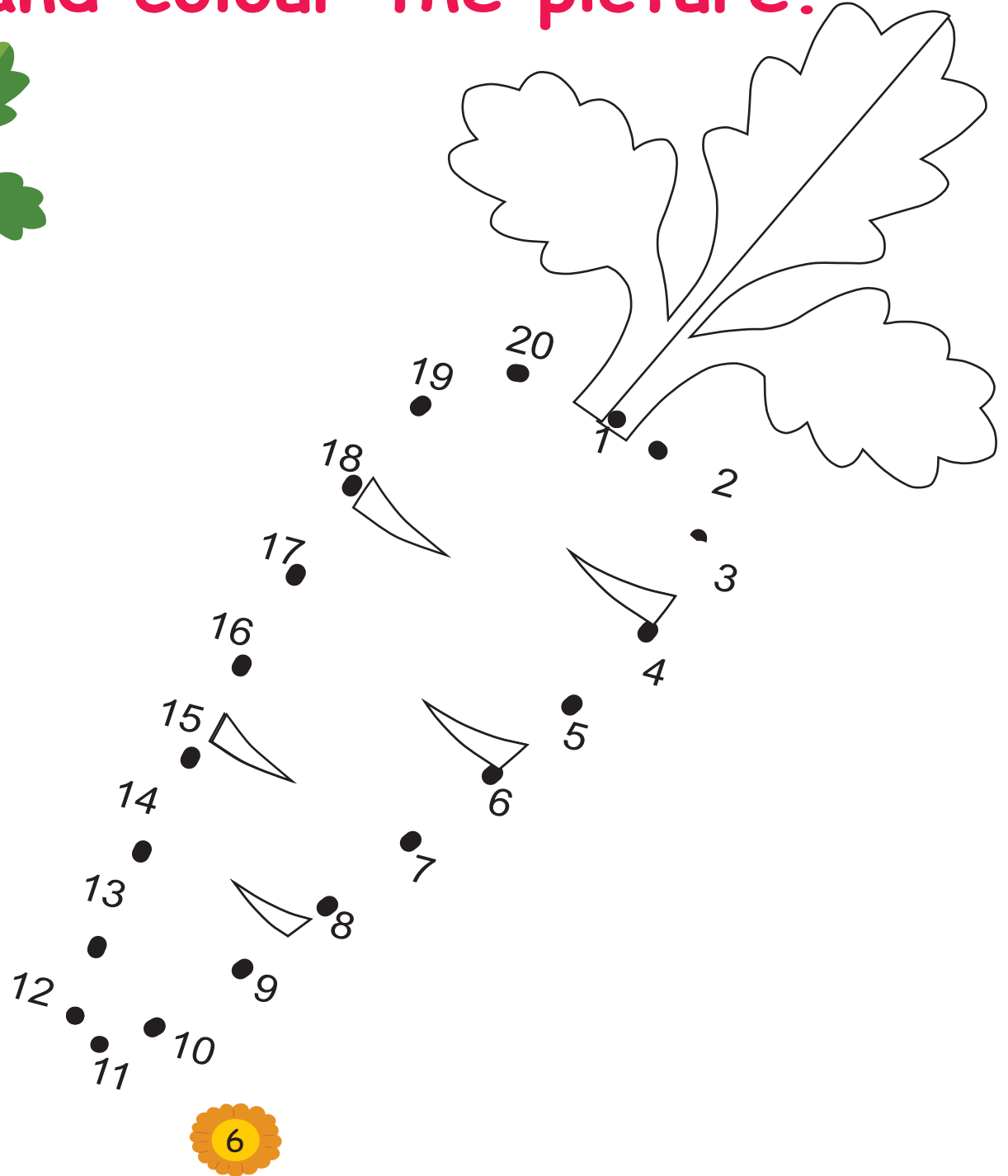

Connect the dots and colour the picture.

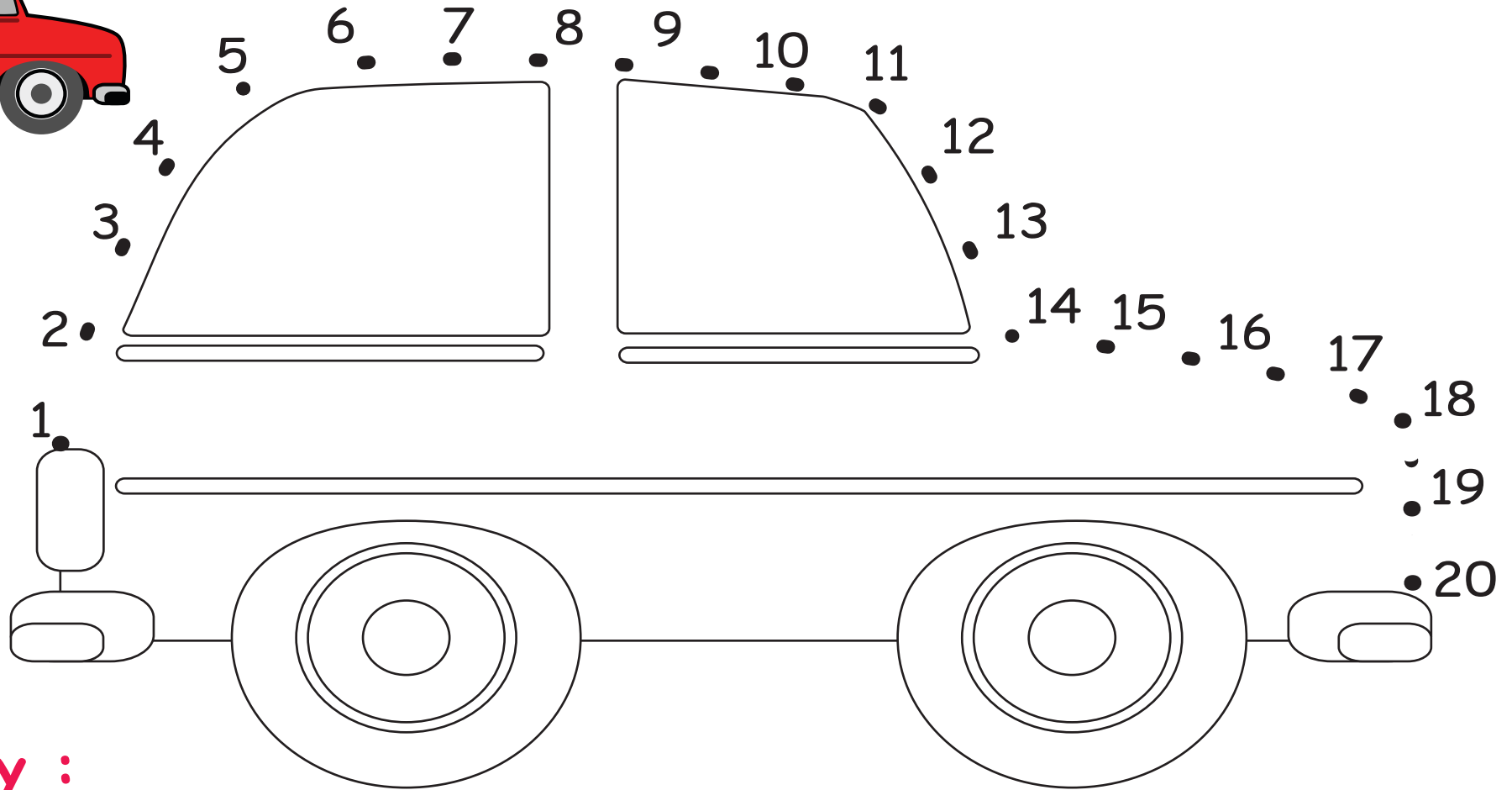

Activity :

1. Identify the picture ?

Ans : _____
(Car / Bike)

2. What is the colour of the picture ?

Ans : _____
(Red / Black)

Connect the dots and colour the picture.

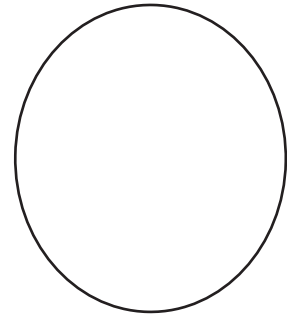
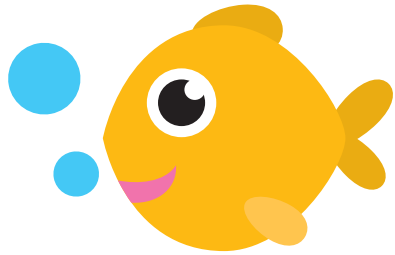

Activity :

1. Identify the picture ?

Ans : _____
(Fish / Dolphin)

2. What is the colour of the picture ?

Ans : _____
(Blue / Yellow)

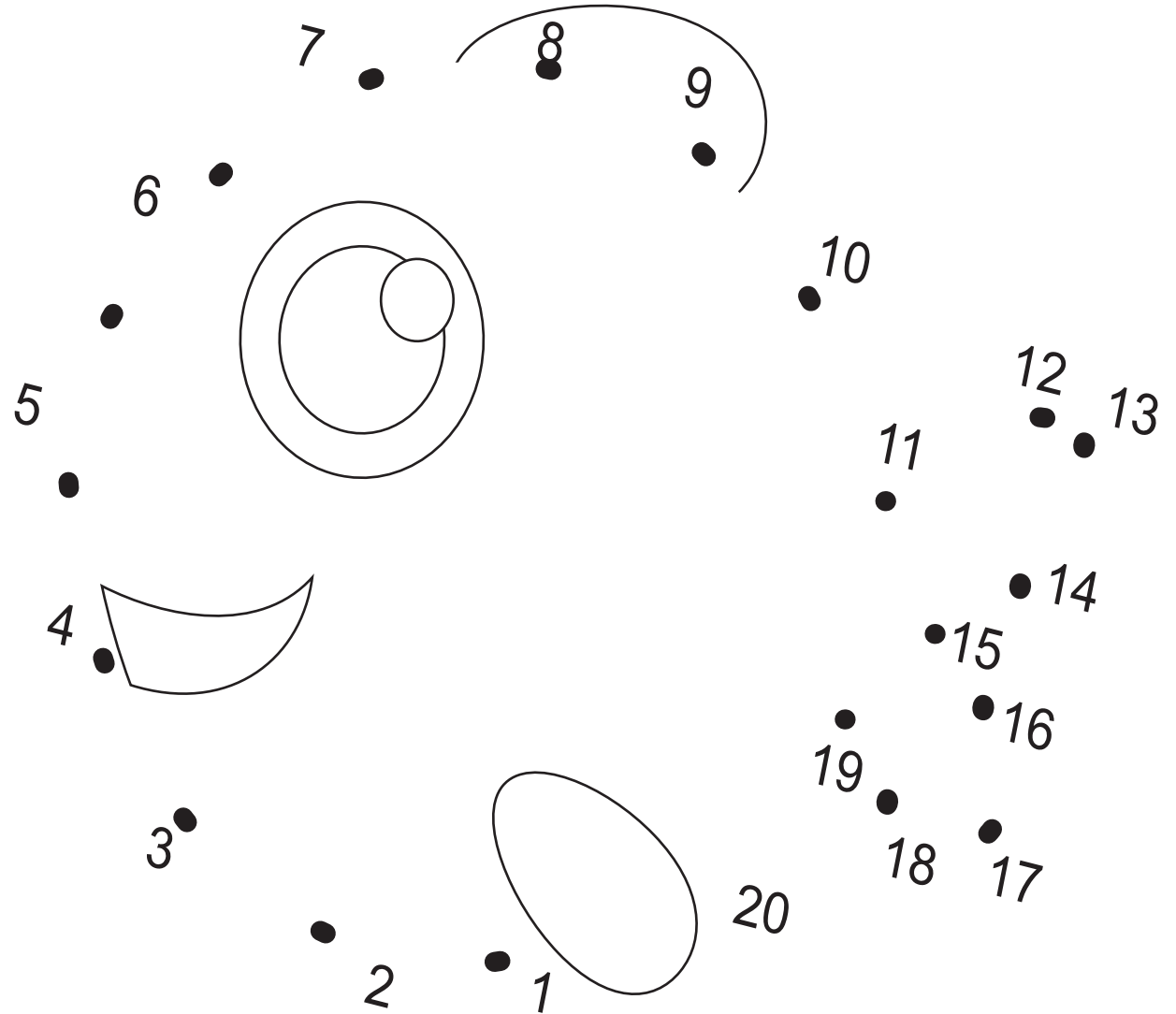

Connect the dots and colour the picture.



Activity :

1. Identify the picture ?

Ans : _____
(Jellyfish / Starfish)

2. What is the colour of the picture ?

Ans : _____
(Pink / White)

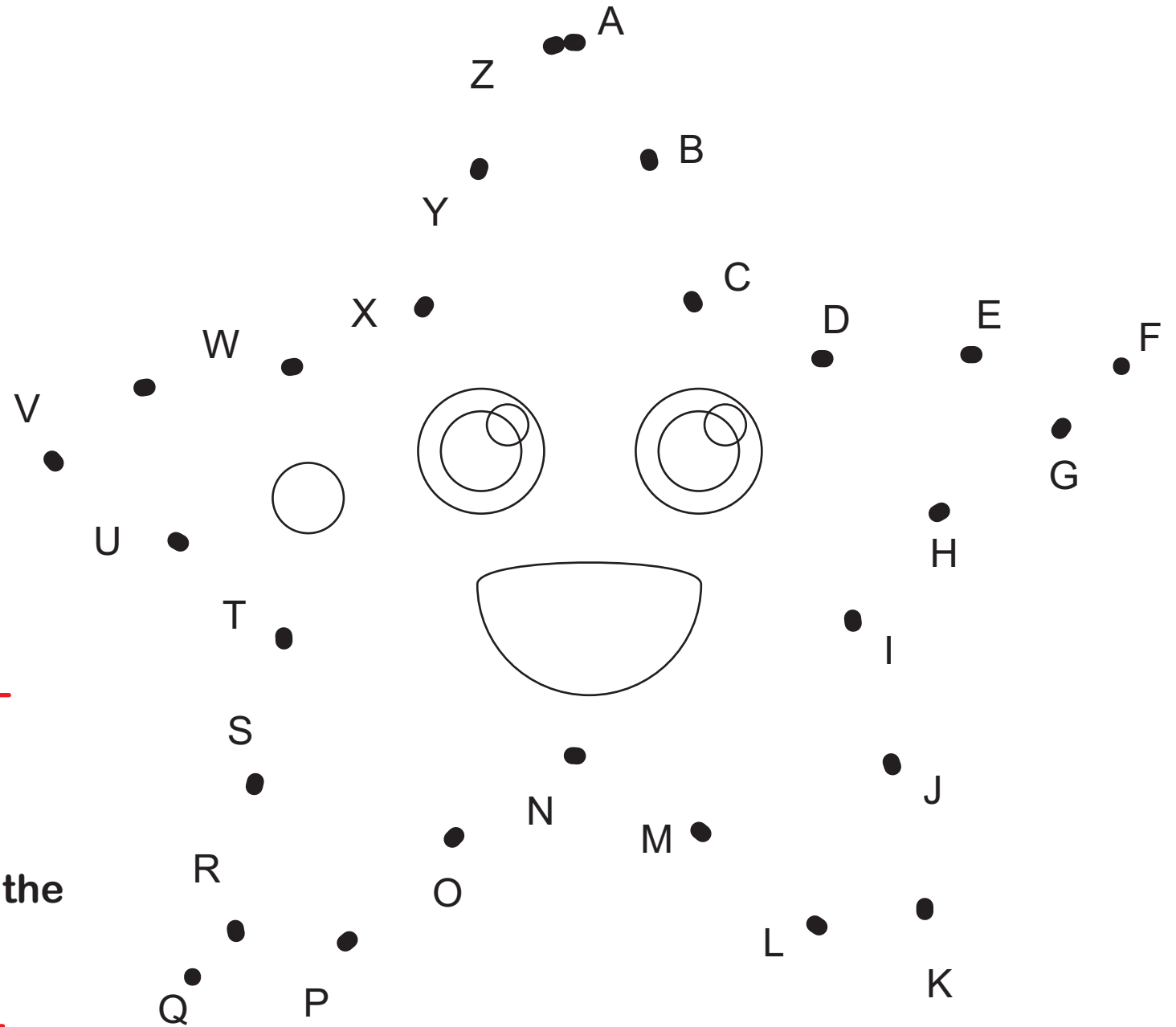

Connect the dots and colour the picture.

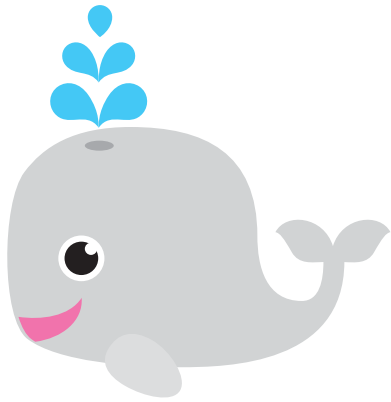

Activity :

1. Identify the picture ?

Ans : _____
(Whale / Shark)

2. What is the colour of the picture ?

Ans : _____
(Blue / Black)

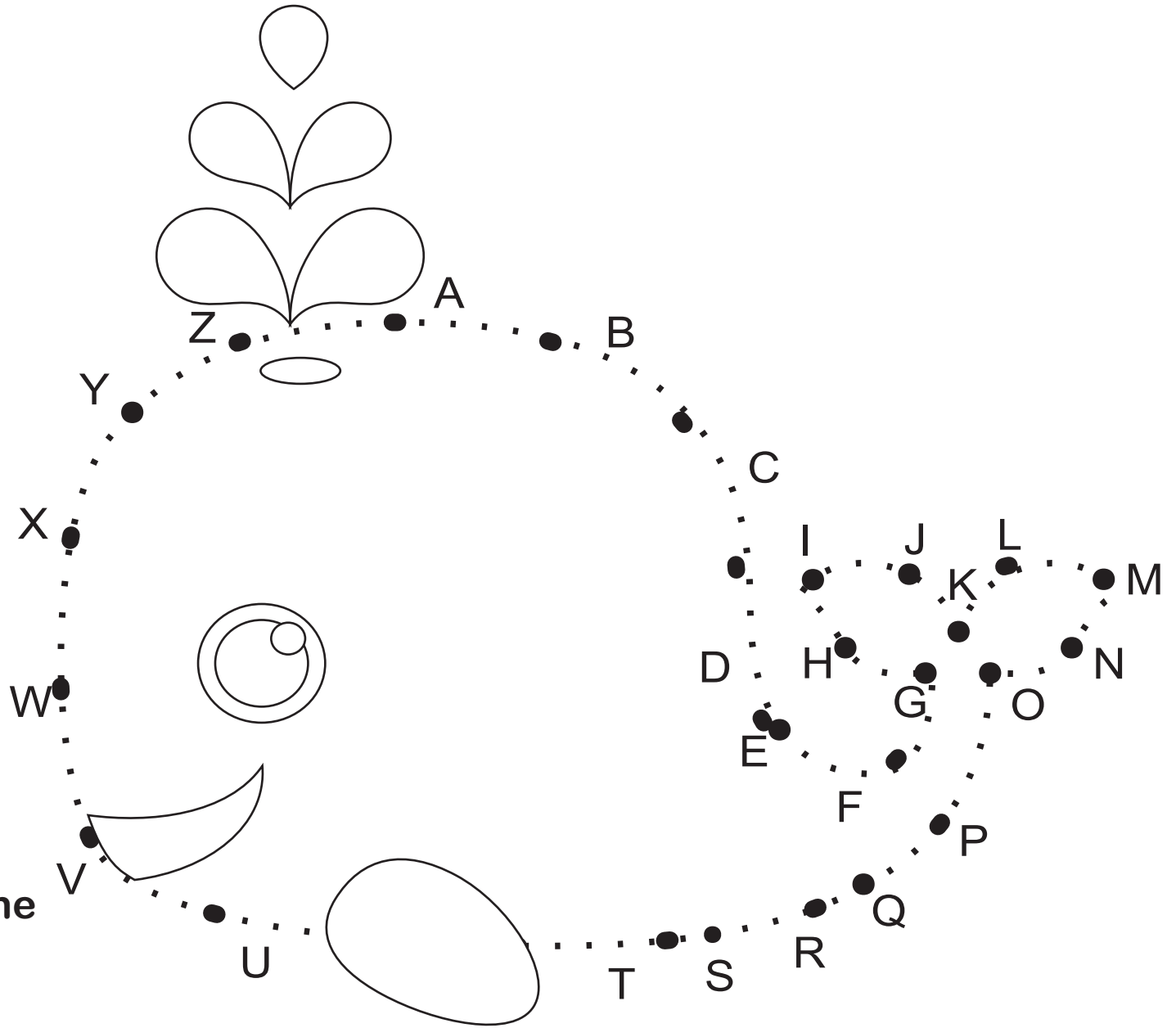

Connect the dots and colour the picture.

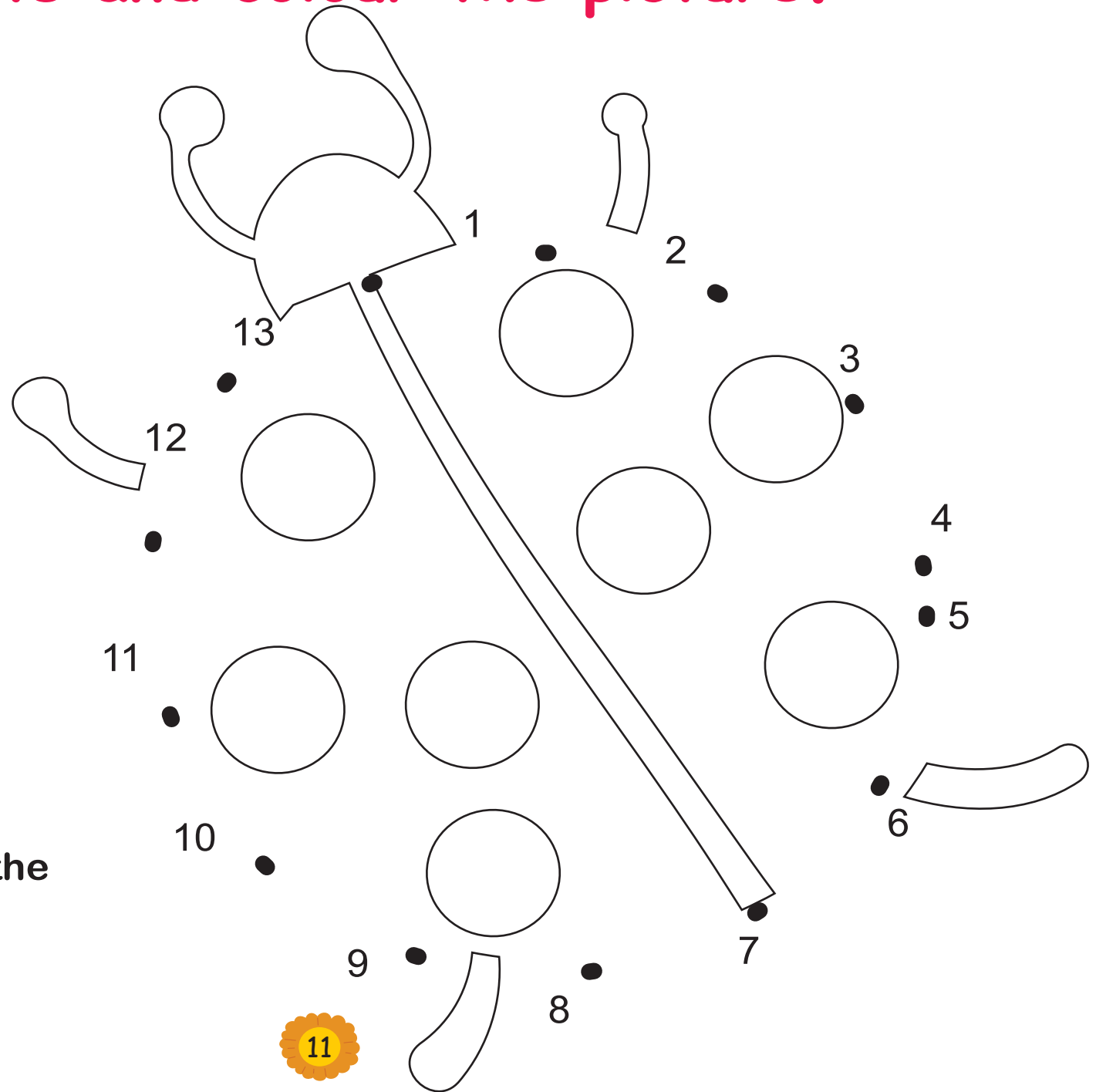

Activity :

1. Identify the picture ?

Ans : _____

(Bug / Cockroach)

2. What is the colour of the picture ?

Ans : _____

(Black / Red)

Connect the dots and colour the picture.

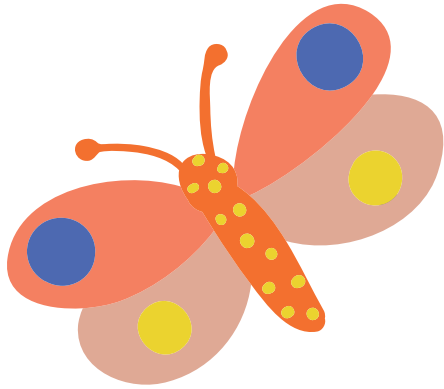

Activity :

1. Identify the picture ?

Ans : _____

(Grasshopper / Butterfly)

2. What is the colour of the picture ?

Ans : _____

(Green / Purple)

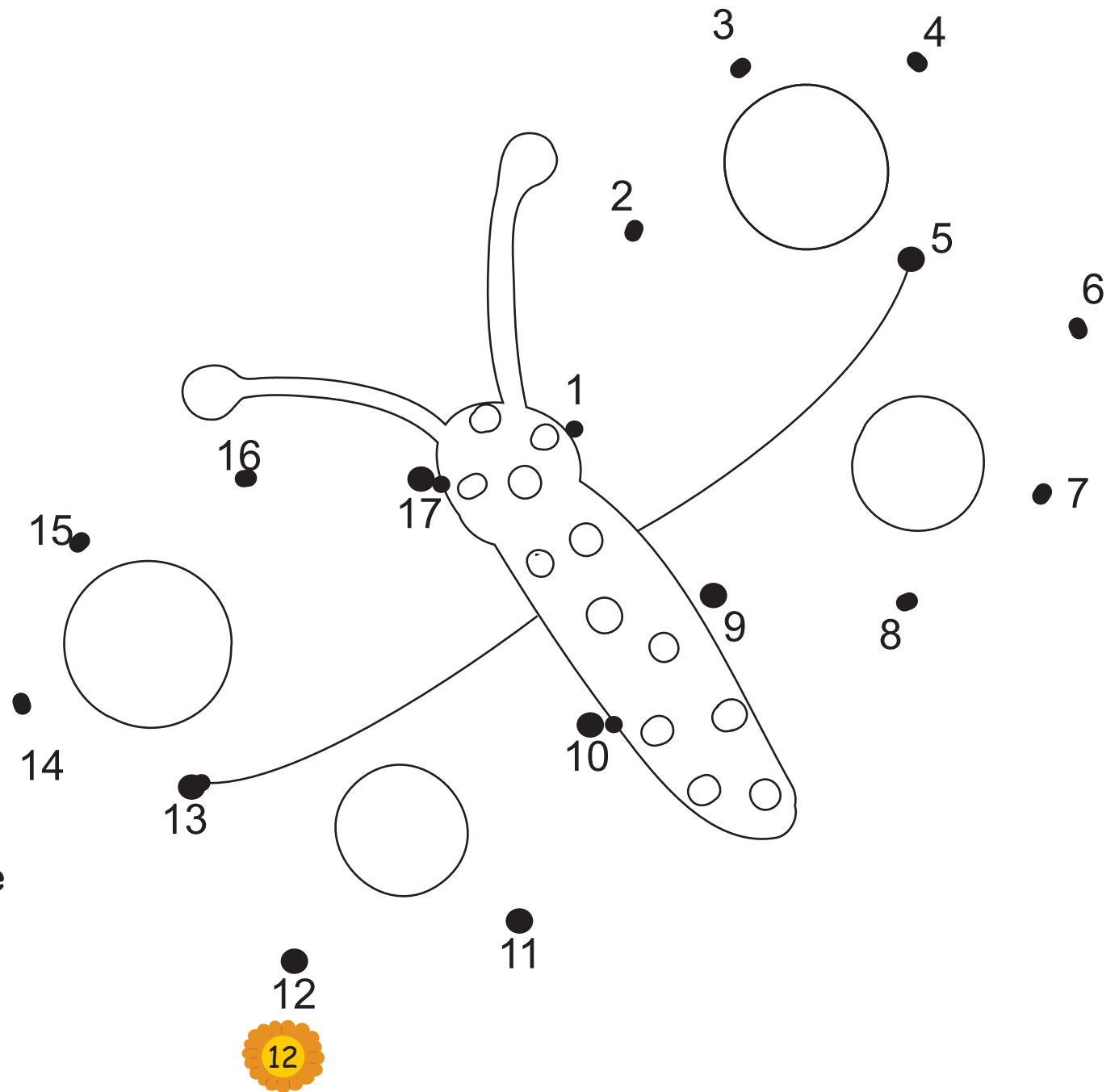

Connect the dots and colour the picture.



Activity :

1. Identify the picture ?

Ans : _____
(Owl / Cat)

2. What is the colour of the picture ?

Ans : _____
(Gray / Brown)

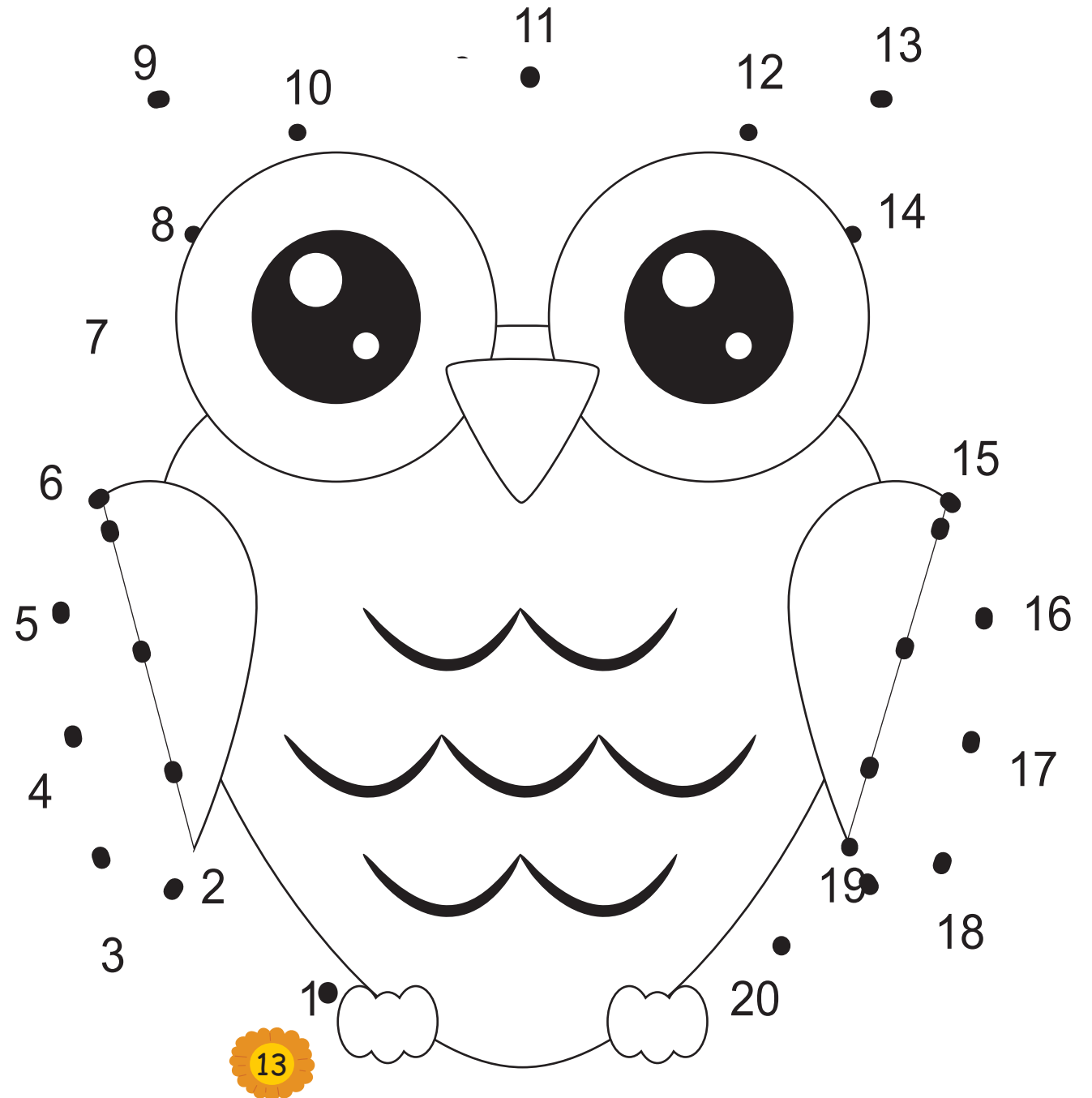

Connect the dots and colour the picture.

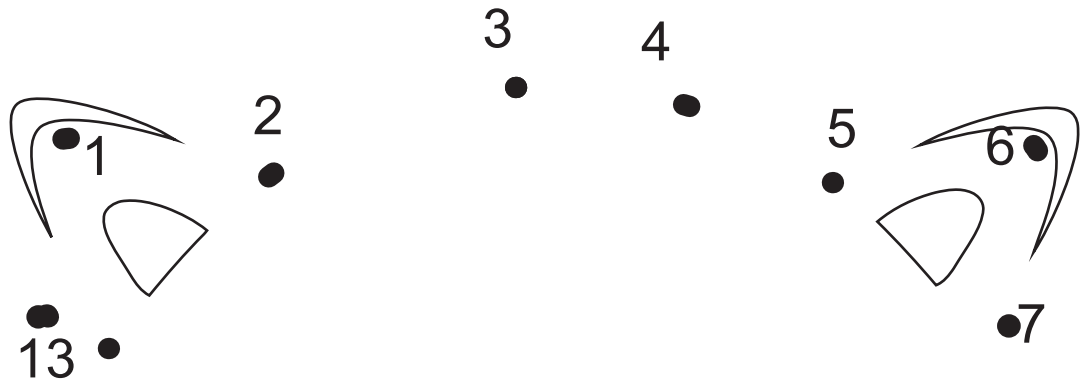

Activity :

1. Identify the picture ?

Ans : _____
(Fox / Dog)

2. What is the colour of the picture ?

Ans : _____
(Brown / Orange)

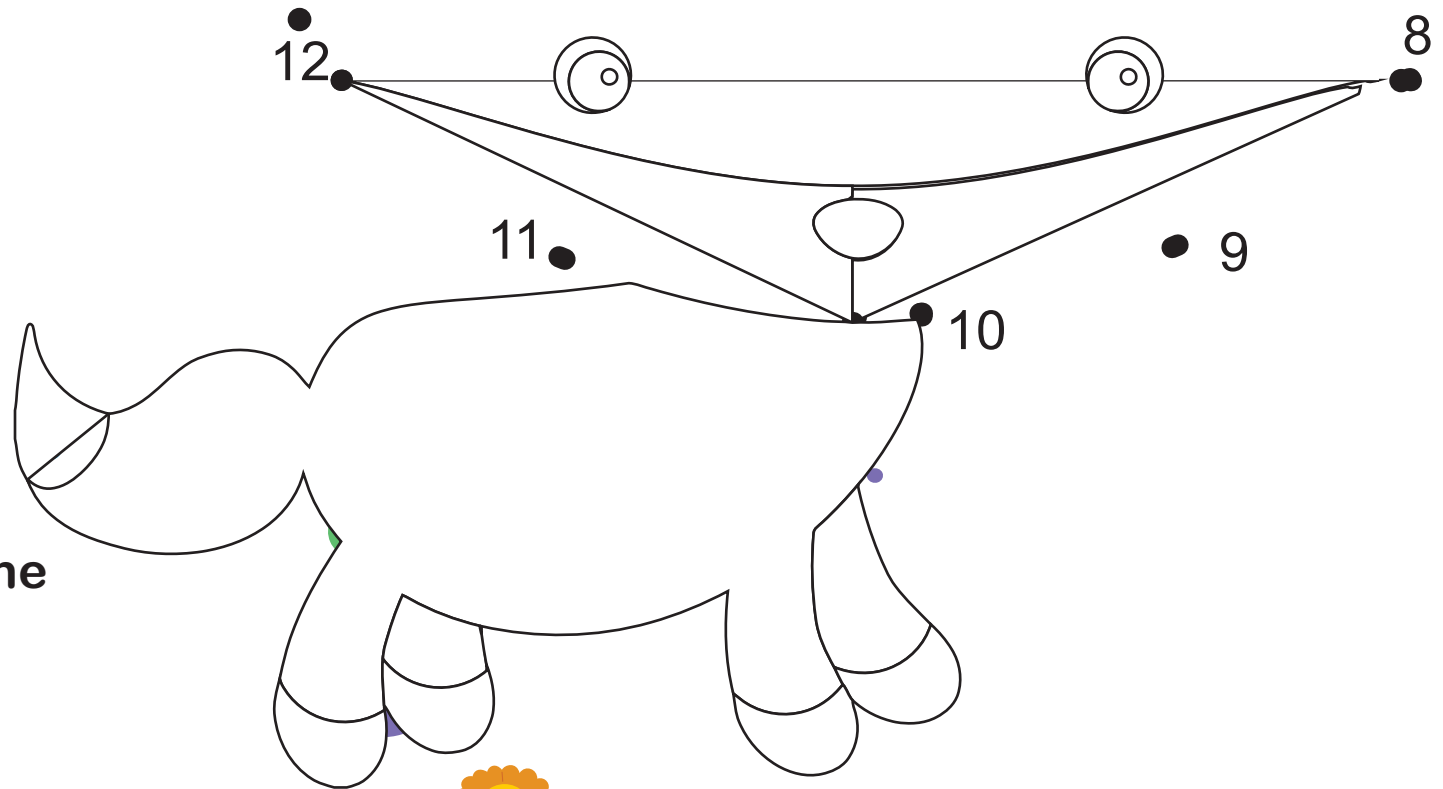

Connect the dots and colour the picture.

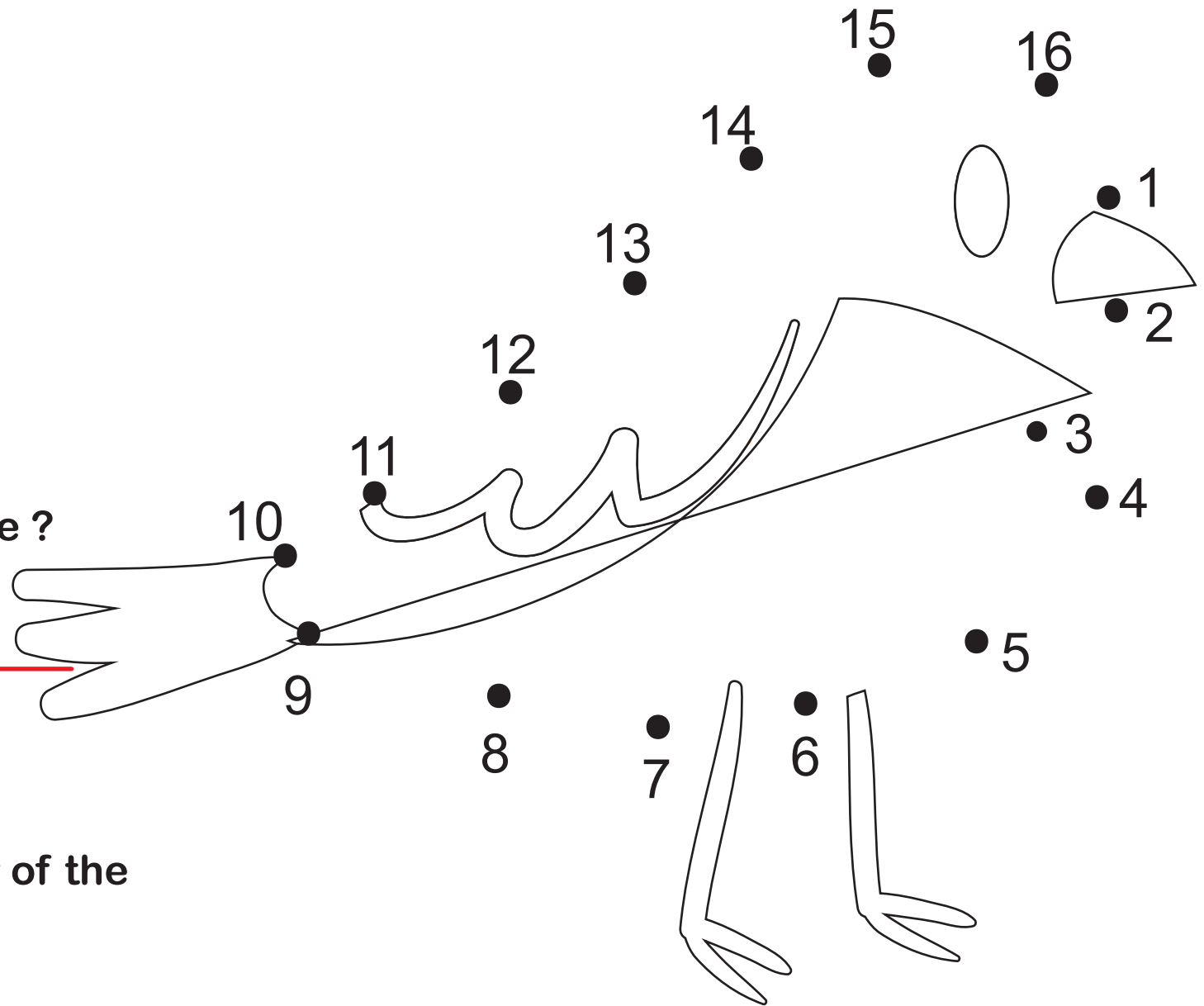

Activity :

1. Identify the picture ?

Ans : _____
(Crow / Sparrow)

2. What is the colour of the picture ?

Ans : _____
(Black / Gray)

Complete the picture and colour it.

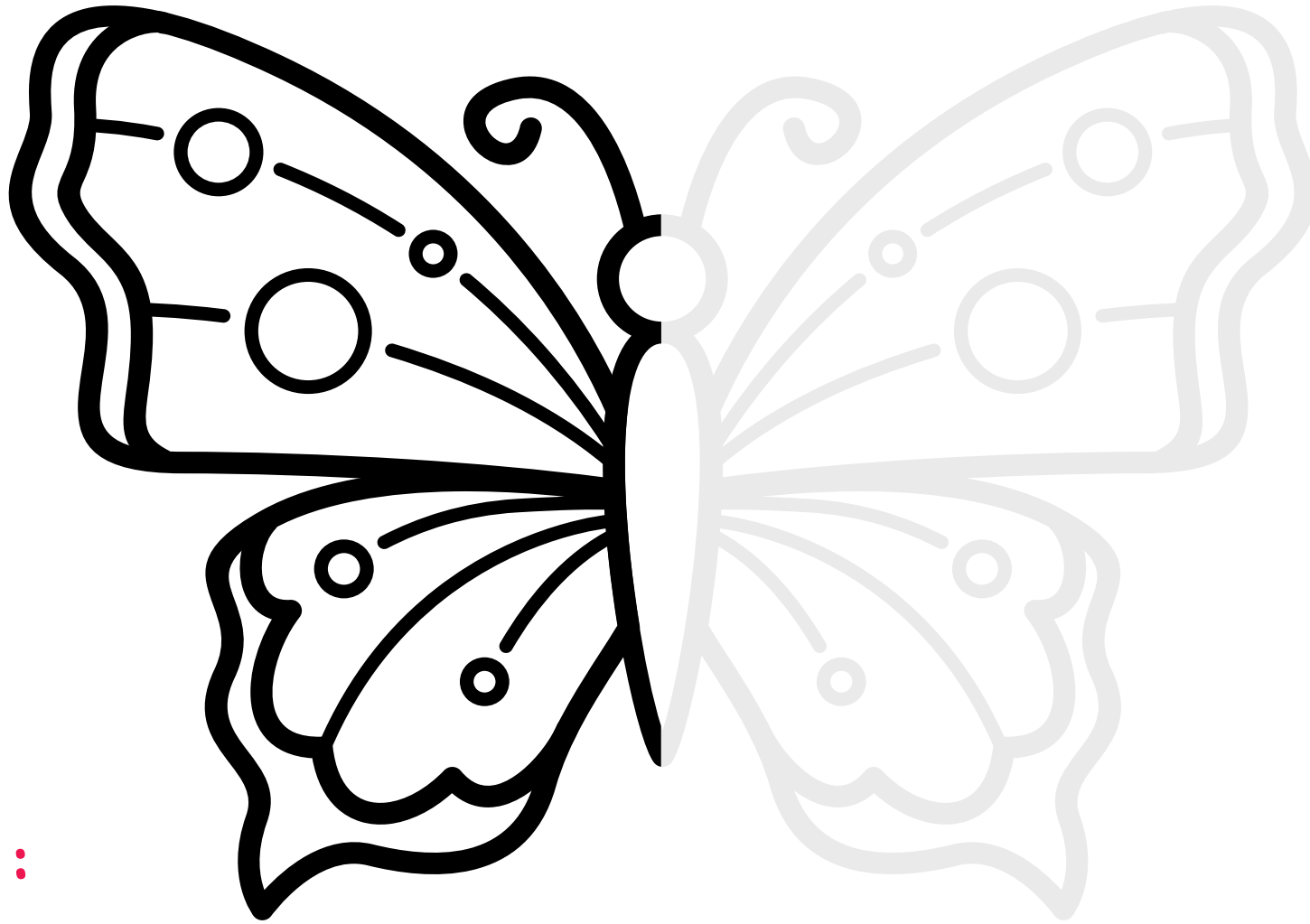

Activity :

1. Identify the picture ?

Ans : _____

(Butterfly / Housefly)

2. What is the colour of the picture ?

Ans : _____

(Purple / Orange)

Complete the picture and colour it.

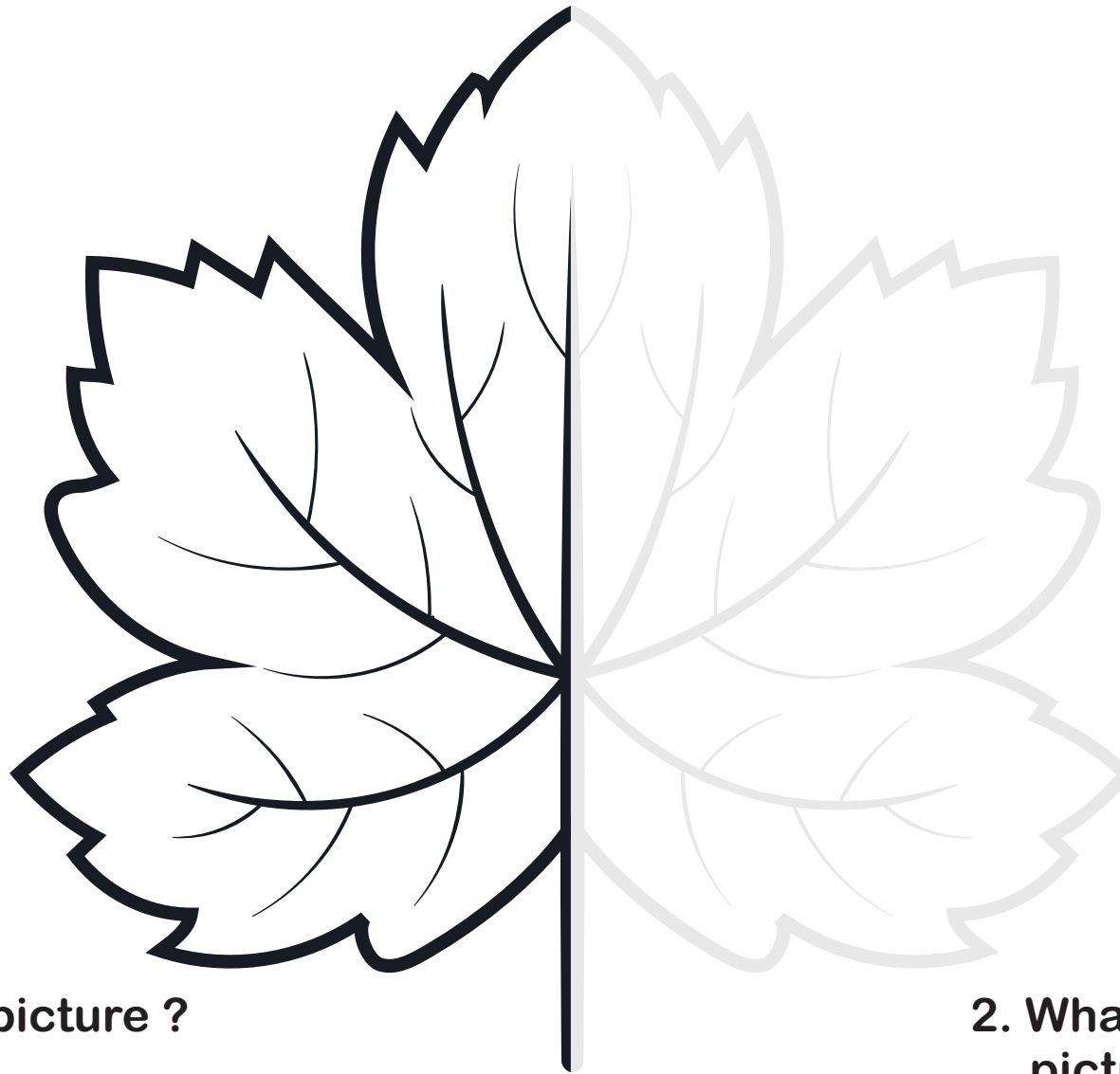

Activity :

1. Identify the picture ?

Ans : _____

(Leaf / Flower)

2. What is the colour of the picture ?

Ans : _____

(Brown / Green)

rocket to the moon

Colour in the rocket ship using the key below.

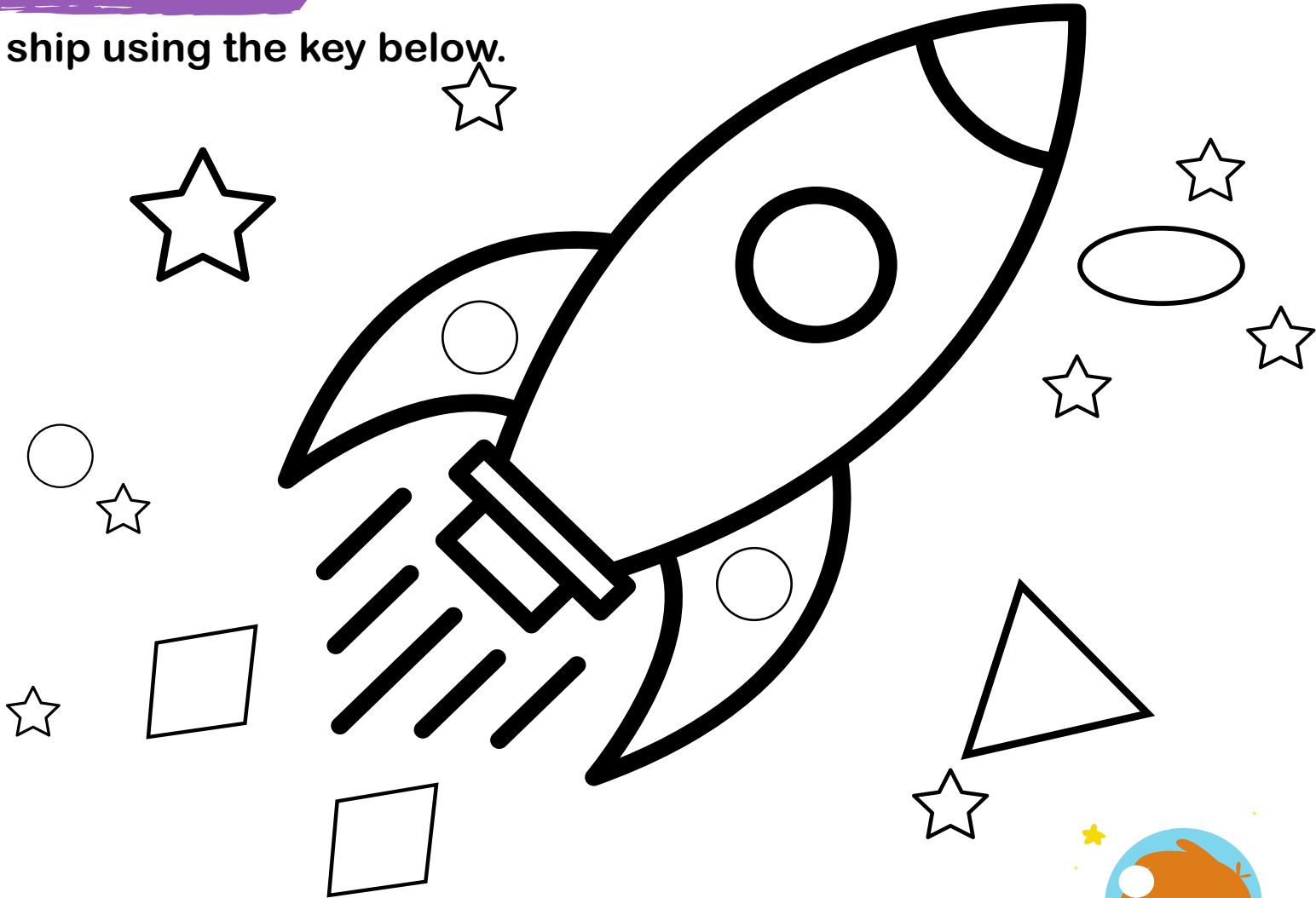

triangle:
green

oval:
blue

diamond:
red

circle:
orange

star:
yellow

My rocket is headed to: _____



Colour the picture with your favorite colours.



Colour the picture with your favorite colours.



Colour the picture with your favorite colours.

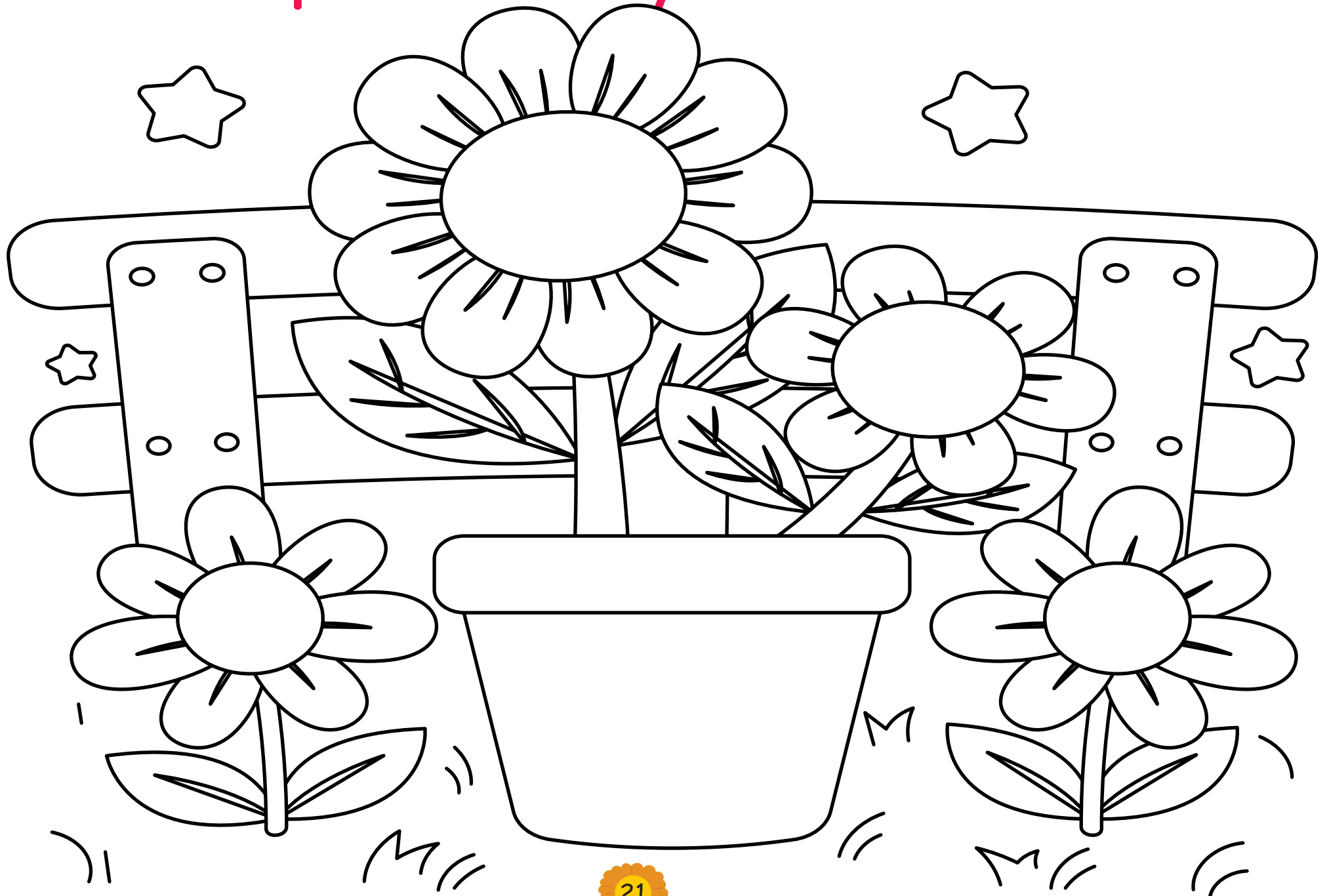

Colour the picture with your favorite colours.

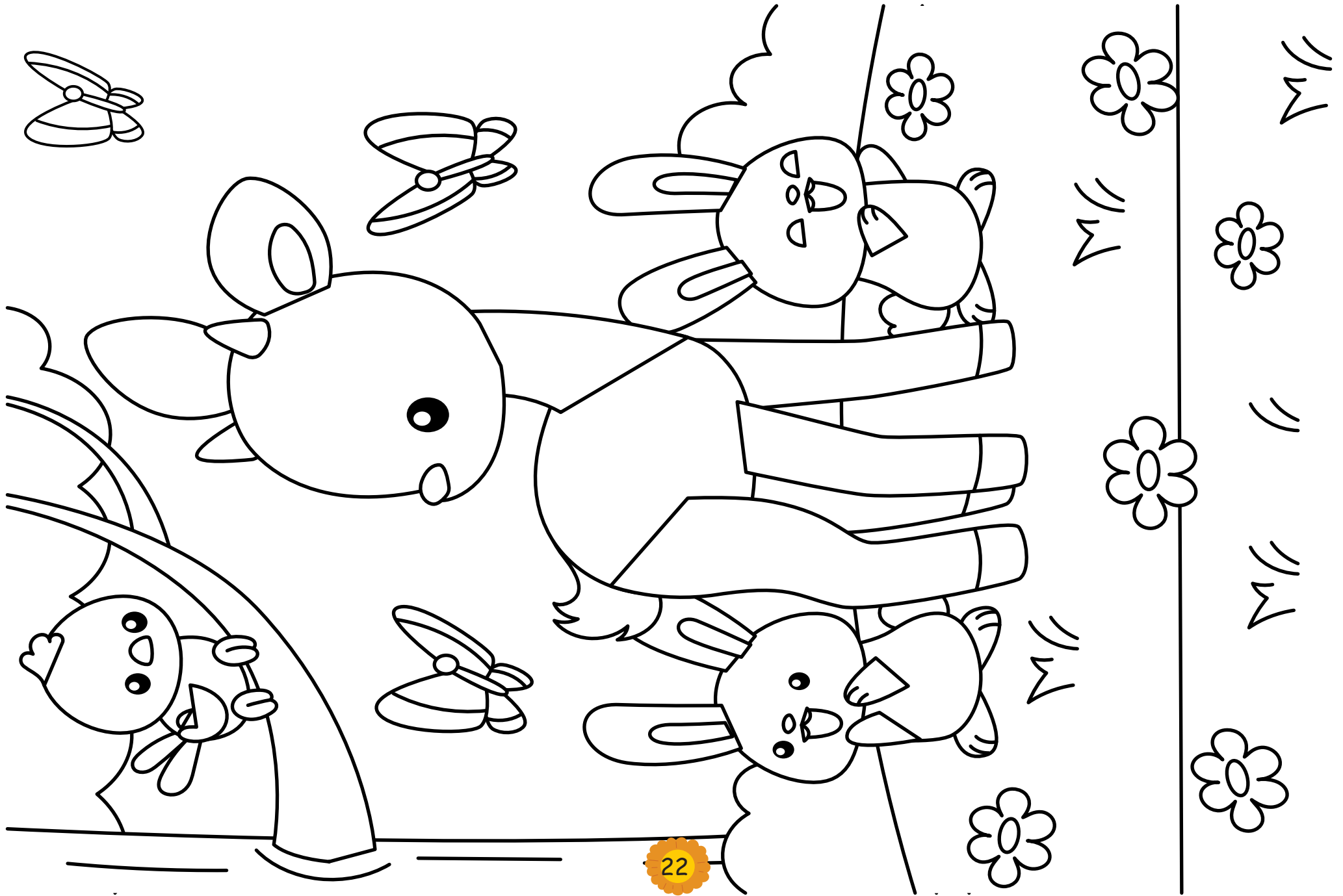

Trace the Path :



Cut the outline and make a wrist bands for yourself.





- **Book Design By** : Shivali A. Puri
- **Printed by** : Sanjay Offset, New Shukrawari, Nagpur.
- **Revised Edition** : 2026

© All Rights Reserved with Publisher.

All Books are Available at :

• Mumbai • Ahmadabad • Hyderabad • Delhi • Bhopal.

₹ 99.00

